

DIAPHRAGM WELL TANK

- **Safety Instructions**
- **Installation**

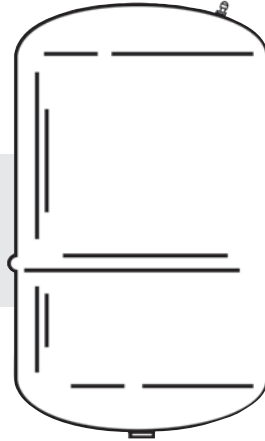

VERTICAL SERIES:
14-20-25-32-36-52-65-86-96-119 GALLON



IN-LINE SERIES:
2-5 & 7 GALLON

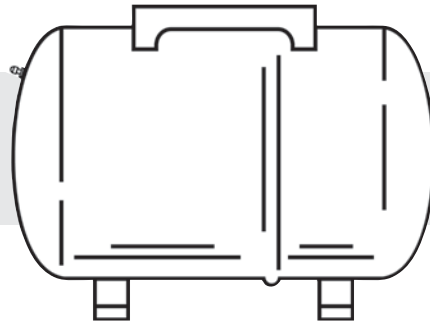

HORIZONTAL SERIES:
7-14 & 20 GALLON



Certified to
NSF/ANSI 61-G

NO LEAD

NO LEAD: The weighted average of the wetted surface of this no lead product contacted by consumable water contains less than one quarter of one percent (0.25%) lead.



⚠ WARNING

Read and understand installation manual and safety messages before installing, operating or servicing this pump tank.

Failure to follow instructions and safety messages could result in death or serious injury.





KEEP THIS MANUAL FOR FUTURE REFERENCE WHENEVER MAINTENANCE ADJUSTMENT OR SERVICE IS REQUIRED.

Water Systems • 4302 RALEIGH STREET • CHARLOTTE, NC 28213

SAFE INSTALLATION, USE, AND SERVICE

The proper installation, use and servicing of this Well Tank is extremely important to your safety and the safety of others.

Many safety-related messages and instructions have been provided in this manual and on your own pump tank to warn you and others of a potential injury hazard. Read and obey all safety messages and instructions throughout this manual. It is very important that the meaning of each safety message is understood by you and others who install, use, or service this pump tank.

	This is the safety alert symbol. It is used to alert you to potential personal injury hazards. Obey all safety messages that follow this symbol to avoid possible injury or death.
	DANGER indicates an imminently hazardous situation which, if not avoided, will result in death or injury.
	WARNING indicates a potentially hazardous situation which, if not avoided, could result in death or injury.
	CAUTION indicates a potentially hazardous situation which, if not avoided, could result in minor or moderate injury.
	CAUTION used without the safety alert symbol indicates a potentially hazardous situation which, if not avoided, could result in property damage.

All safety messages will generally tell you about the type of hazard, what can happen if you do not follow the safety message, and how to avoid the risk of injury.

IMPORTANT INSTRUCTIONS BEFORE INSTALLATION

⚠ WARNING

FAILURE TO FOLLOW THESE INSTRUCTIONS MAY CAUSE SERIOUS BODILY INJURY AND/OR PROPERTY DAMAGE.

1. All piping and electrical wiring must adhere to state and local codes. Check with appropriate community agencies, or contact your local electrical and pump professionals.
2. Install tank as close as possible to the pump pressure switch to reduce friction loss and elevation difference between the tank, water supply main, and switch.
3. After installation, be sure the pressure switch is set low enough to shut the pump off. If all valves are closed and the pressure switch setting is too high, the pump will run continuously without water flow causing overheating and damage to the pump.
4. A pressure relief valve must be installed in the piping adjacent to the Well Tank.
5. The following may cause severe damage to tank and/or piping and will void warranty.
 - Failure to protect tank against below-freezing temperatures.
 - Pumping chemicals or corrosive liquids.
 - Pumping gasoline or other flammable liquids.
 - Operation at pressures greater than rated pressure on data plate with no relief valve.
 - Pumping liquids hotter than 120°F.

⚠ WARNING

Improper installation, adjustment, alteration, service or maintenance can cause DEATH, SERIOUS BODILY INJURY, OR PROPERTY DAMAGE. Refer to this manual for further assistance.

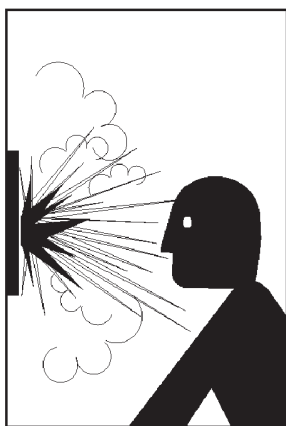

⚠ WARNING **Explosion Hazard**

- Over-pressurized water can cause water tank to explode.
- Properly sized pressure relief valve must be installed in piping adjacent to pump tank.
- Failure to follow these instructions could result in death or serious injury.

This Well Tank is designed and intended for cold (ambient temperature) water storage at a maximum pressure of 100 PSIG or 125 PSIG depending on your tank model, any use other than with cold water, or at a sustained or instantaneous pressure in excess of 100 PSIG or 125 PSIG depending on your tank model is UNSAFE. A pressure relief valve of adequate size must be incorporated in the system. The relief valve must be selected to pass the full capacity of the pump when the pressure in this tank is 100 PSIG or more. Consult pump manufacturer for pump capacity at relief pressure. The manufacturer of this tank does not accept any liability or other responsibility for personal injury or property damage resulting from improper use, installation, or operation of this tank, or of the system of which it is a part.

⚠ WARNING

Failure to follow these instructions can cause the tank to explode and result in DEATH, SERIOUS BODILY INJURY, OR PROPERTY DAMAGE.

Depending on your tank model, install a 125 P.S.I. or less pressure relief valve directly into a fitting of the plumbing. Position the valve downward and provide piping so that any discharge will exit only within 6 inches above, or at any distance below the structural floor. Be certain that no contact is made with any live electrical part. The discharge opening must not be blocked or reduced in size under any circumstances. Excessive length, over 15 feet, or in use of more than two elbows can cause restriction and reduce the discharge capacity of the valve.

No valve or other obstruction is to be placed between the relief valve and the tank nor in the discharge line. Do not connect piping directly to discharge drain unless a 6" air gap is provided. To prevent bodily injury or hazard to life, the valve must be able to discharge large quantities of water should circumstances demand. If the discharge pipe is not connected to a drain or other suitable means, the water flow may cause property damage.

The Discharge Pipe:

- Must not be smaller in size than the outlet pipe size of the valve, or have any reducing couplings or other restrictions.
- Must not be plugged or blocked.
- Must be installed so as to allow complete drainage of both the pressure relief valve, and the discharge pipe.
- Must not have any valve between the relief valve and tank.

⚠ WARNING

The complete pump, tank, pressure relief valve, pressure switch and piping system MUST be protected against below freezing temperature. Failure to do so could cause the tank to explode and result in DEATH, SERIOUS BODILY INJURY, OR PROPERTY DAMAGE.

The well tanks are designed for operation on water systems with working pressure not to exceed 100 PSIG or 125 PSIG depending on your tank model. Pressure exceeding this could become hazardous, and will void any and all guarantees, either written, or implied.

IMPORTANT

It will be necessary to expel all air from piping after new installations, repriming and after pumps have been disassembled for repair. To purge the air, first open a faucet the greatest distance from the pump. With the pump being allowed to run, wait until a steady stream of water is coming from the faucet. At this time, close the faucet for several short intervals.

If, after this, air in the lines still occurs, check on the suction side of the pump for piping leaks.

When standard type tanks are replaced with this tank, all air charging devices, bleeder orifices, and air volume controls must be removed.

The pump tank has been shipped with a factory precharge as indicated on Table 1. If your pump start-up pressure is different from the factory precharge, adjust the tank pressure with the tank empty to your pump start-up pressure. This can be accomplished by simply bleeding air from valve in the top of the tank with an accurate pressure gauge. Using the same standard air charging valve in the top tank, a tire pump can be used to raise the tank pressure. Raise the pressure slowly, checking it periodically with an accurate tire pressure gauge, until the desired pressure is reached.

FEATURES AND OPERATING CYCLES

SHELL constructed of light-weight drawn steel with epoxy finish provides extra corrosion-resistance.

STRONG AND FLEXIBLE BUTYL DIAPHRAGM assures dependable tank service even with pressures up to 125 PSI.

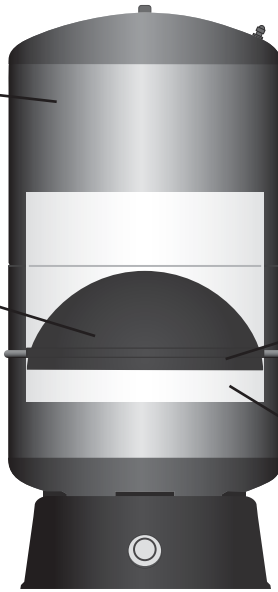

DIAPHRAGM SEAL consists of locking retainer ring for positive separation of air and water.

LINING protects inner shell against rust in water reservoir.

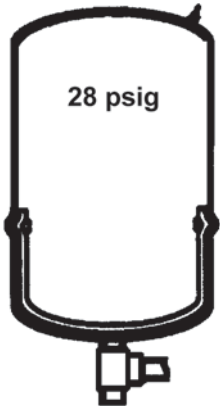

START-UP CYCLE

The diaphragm is pressed against the bottom of the air chamber



FILL CYCLE

Water is pumped into the reservoir, which forces the diaphragm upward into the air chamber.



HOLD CYCLE

Pump attains cut-off pressure. Diaphragm reaches uppermost position. Reservoir is filled to capacity.

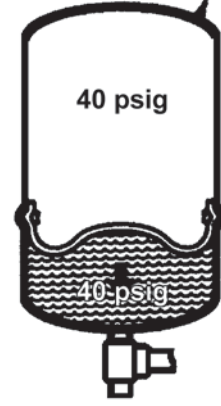

DELIVERY CYCLE

Pump remains off while pressure in air chamber forces diaphragm downward to deliver water.

Example of how a 30-50 PSI system works

FIGURE 1

TANK SPECIFICATIONS

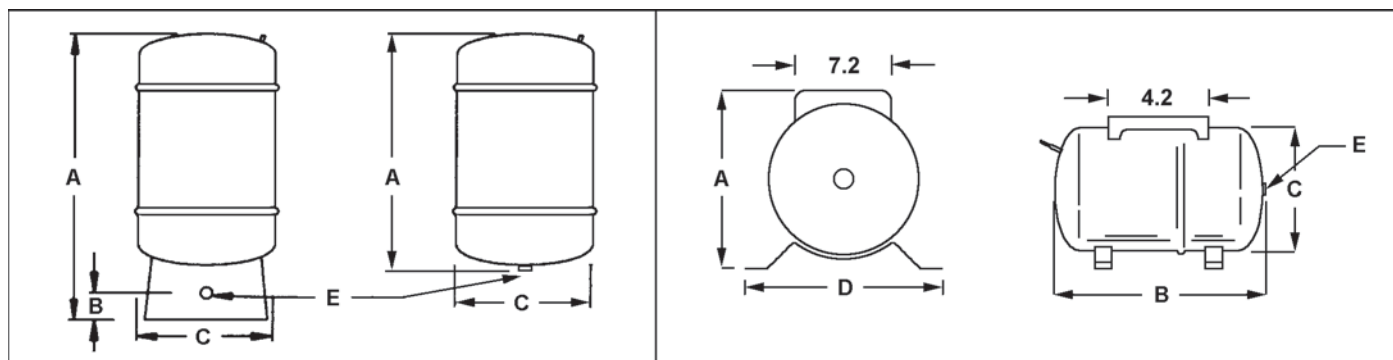

FIGURE 2

Capacity in Gallons	Drawdown in Gallons			Precharge Pressure	Dimensions in Inches				Discharge Connection	Weight in Pounds
	20-40 PSI	30-50 PSI	40-60 PSI		A	B	C	D		
(In-Line)										
2	0.7	0.6	---	38 PSI	10-3/16	---	8-1/4	---	3/4 NPTM	5.0
5	1.6	1.4	---	38 PSI	14-3/4	---	11	---	3/4 NPTM	9.0
7	2.5	2.1	---	38 PSI	21-1/16	---	11	---	3/4 NPTM	14.0
(Free-Standing)										
14	5.2	4.3	3.7	38 PSI	24-3/4	2-1/4	15-3/8	---	1" NPTF	25.5
20	7.4	6.2	5.4	38 PSI	32-3/4	2-1/4	15-3/8	---	1" NPTF	30.0
25	9.2	7.7	6.7	38 PSI	26-1/2	2-1/4	20	---	1" NPTF	36
32	11.5	9.6	8.4	38 PSI	45-1/2	2-1/4	15-3/8	---	1" NPTF	40.0
36	13.3	11.1	9.7	38 PSI	32-3/8	2-1/4	20	---	1" NPTF	45.0
52	19.2	16.1	14	38 PSI	38-5/8	2-1/4	23-3/8	---	1-1/4" NPTF	77.0
65	23.9	20	17.5	38 PSI	46.6	2-1/4	23-3/9	---	1-1/4" NPTF	87.0
86	31.8	26.7	23.2	38 PSI	59	2-1/4	23-3/8	---	1-1/4" NPTF	105.0
96	35.5	29.8	25.9	38 PSI	63-3/8	2-1/4	23-3/8	---	1-1/4" NPTF	111.0
119	44	37	32	38 PSI	61-1/4	2-1/2	26	---	1-1/4" NPTF	165.0
(Horizontal)										
7	2.5	2.1	---	38 PSI	12-7/8	21-1/8	11	12-1/2	3/4 NPTM	16.0
14	5.2	4.3	3.7	38 PSI	17-3/8	21-3/4	15-3/8	12-1/2	1" NPTM	25.5
20	7.4	6.2	5.4	38 PSI	17-3/8	27-1/8	15-3/8	12-1/2	1" NPTM	30.0

TABLE 1

Piping

PVC pipe is shown in the illustrations, but copper or galvanized steel pipe may be used if desired. All piping must be clean and free of all foreign matter. **ALL JOINTS AND CONNECTIONS IN THE SYSTEM MUST BE AIRTIGHT.** A pin-hole leak will prevent proper operation of system (this is the most common problem). Use thread compound on all threads unless specified otherwise.

Draining for servicing or for Winter

The system should be drained before it is disconnected for servicing, or if it is inoperative for an extended period of time, or if it is in danger of freezing. To Drain:

- Follow the instructions in your pump installation manual to drain the pump.
- Open tank drain cock to drain tank.
- Drain all piping to a point 3 feet below ground level.

DIAPHRAGM TANK INSTALLATION

All diaphragm tanks are recommended for clear water applications. Vertical tanks are the most commonly used tanks. However, horizontal tanks and in-line tanks may be used where space is more critical. See Tank Specifications for tank capacity.

General Materials*

- One can PVC cement (read instructions carefully)
- One can thread compound (read instructions carefully)
- One gate valve
- One 1/2" relief valve

- Enough rigid PVC pipe and couplings to reach from pump to pressure tank to service line.
- One male PVC adapter
- One tank cross
- Two 3/8" plugs
- One 1/2" boiler drain
- One 1/2" street tee

Tools Needed for All Pump Installations

Pipe wrench, crescent wrench, 24-tooth hacksaw, round file or knife.

REMINDER: All joints and connections must be airtight. A single pin-hole leak will prevent the proper operation of the system. Use thread compound on all threaded connections unless specified otherwise.

* list is for 1" piping installation, if you are installing 1-1/4" pipe change sizes accordingly.

TYPICAL SUBMERSIBLE PUMP INSTALLATION

STEP 1

Complete pump assembly and electrical connections as specified in pump installation manual. Place tank in desired location and level it.

STEP 2

Thread tank tee into pressure tank so that the two 1/4" holes in the tee face upward. Thread street tee into front of tank tee.

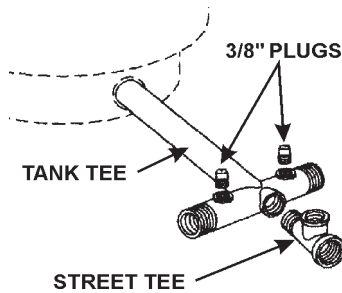

STEP 3

Thread 3/4" male PVC adapter into the inlet side of tank tee.

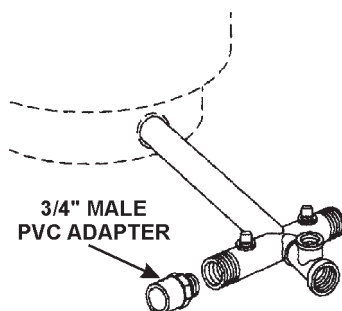

STEP 4

Thread pressure relief valve into top of street tee. Thread 1/2" boiler drain into front of street tee. Cut and cement as many sections and couplings of PVC pipe needed to connect 3/4" male PVC adapter to pump discharge.

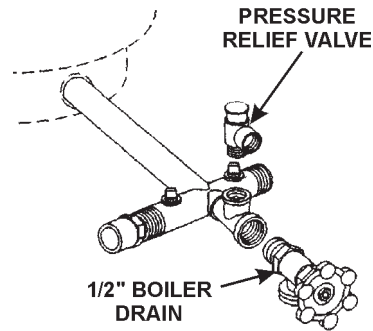

Complete installation should look like Figure 3 shown below.

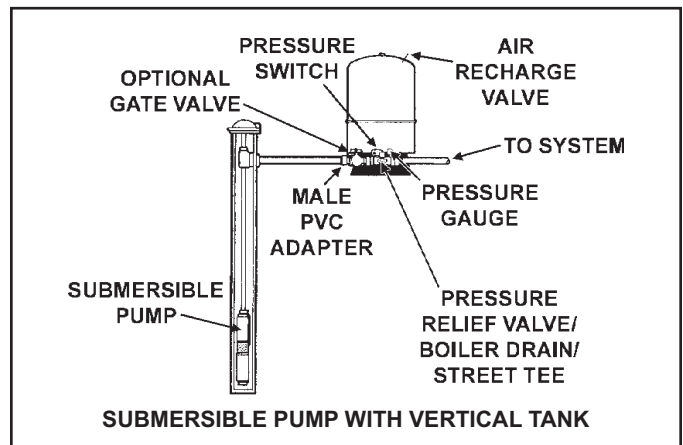
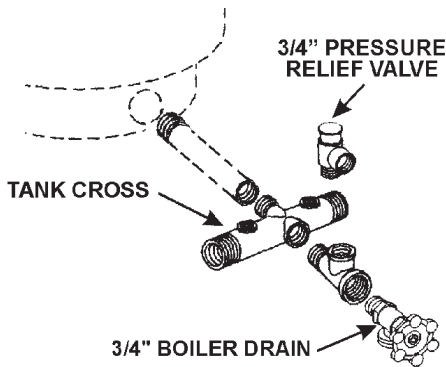

FIGURE 3

TYPICAL JET PUMP INSTALLATION

STEP 1

Thread 10" X 1" nipple into pressure tank. Thread tank cross into nipple so that the two 1/4" holes in tank cross face upward. Thread street tee into front of tank cross. Thread pressure relief valve into top of street tee and thread 3/4" boiler drain into front of street tee.



STEP 2

Thread 1" male PVC adapter into the inlet side of tank cross.

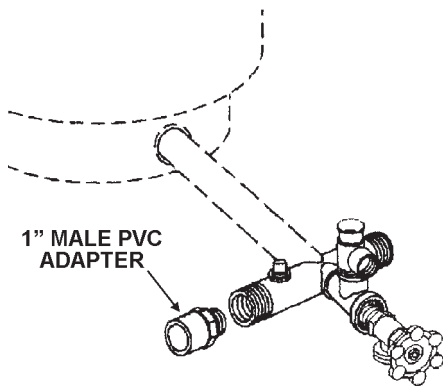

STEP 3

Thread one end of 1/4" X 3" brass nipple into bottom of pressure switch. Thread other end into left 1/4" hole of tank cross. Thread pressure gauge into right 1/4" hole of tank cross. Cut and cement as many sections and couplings of PVC pipe needed to connect the 1" male PVC adapter to pump discharge.

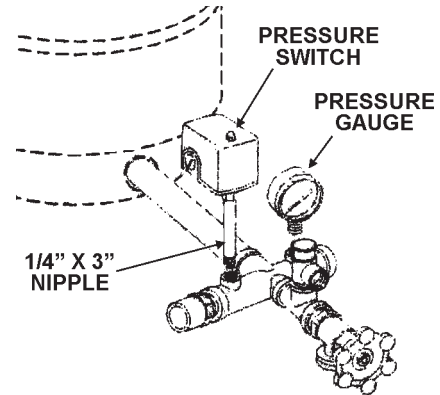

Complete installation should look like Figure 4 shown below.

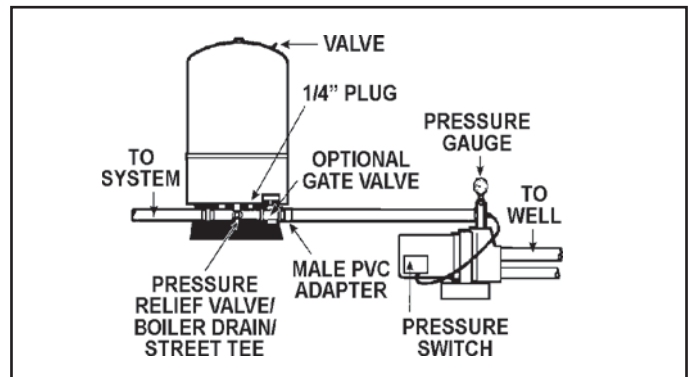

BASE MOUNTED JET PUMP WITH VERTICAL TANK

FIGURE 4

JET PUMP MOUNTED ON HORIZONTAL TANK

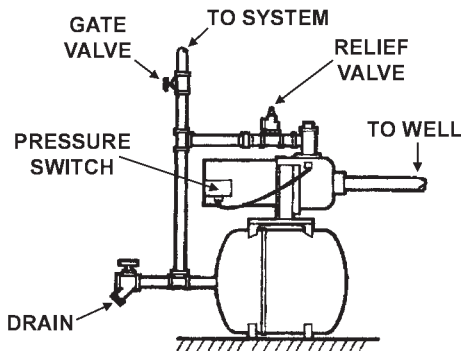

JET PUMP WITH IN-LINE TANK

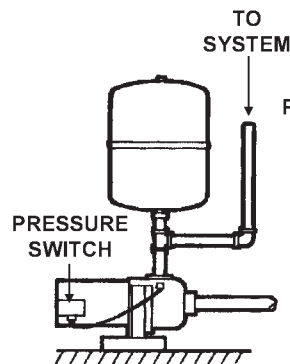

JET PUMP MOUNTED ON VERTICAL TANK

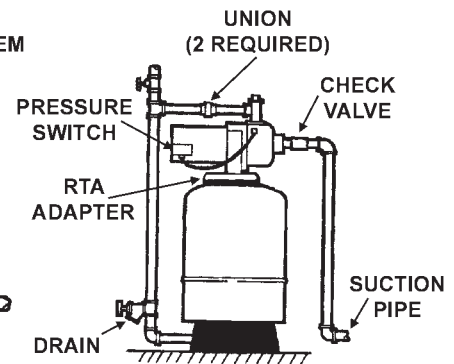

NOTE: NO PRESSURE RELIEF VALVE SHOWN (but is required) ON JET PUMP WITH IN-LINE DRAWING AND JET PUMP MOUNTED ON VERTICAL TANK DRAWING.

FIGURE 5

Setting the Tank Pressure

The tank pressure must be set 2 PSI lower than the pump cut-on pressure. Check tank pressure with a standard air gauge at the top of the tank as needed.

Other Tank Installations

Where space is a critical factor, the in-line tank may be used or the pump may be mounted on either the horizontal or vertical tanks. Various installations are shown. Also, to increase tank capacity up to even industrial levels, multiple tanks may be installed on the same line. See Figure 6. Consult your local pump professional for your particular installation.

MULTIPLE VERTICAL TANKS

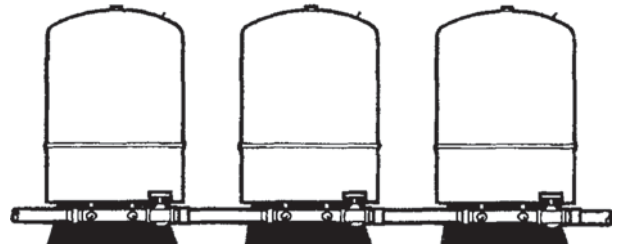

FIGURE 6

NOTES

NOTES

NOTES

FIVE YEAR LIMITED WARRANTY ON WELL TANKS

The "COMPANY" warrants this Well Tank in case of a leak within five (5) years from the date of purchase or in the absence of a Bill of Sale verifying said date, from the date indicated on the model and rating plate affixed to this tank. In case of a defect, malfunction, or failure to conform to this warranty, the Company will repair or replace this tank. No labor, installation, or freight (if any) charges are included in this warranty. You must pay these costs.

Prior to return of the well tank or part to the manufacturer for inspection, the Company will, if requested, ship a replacement pump tank or part C.O.D. and later provide such reimbursement as subsequent inspection indicates is due under these warranties.

EXCLUSIONS AND LIMITATIONS OF THESE LIMITED WARRANTIES

1. The limited warranties provided herein are in lieu of any and all warranties, expressed or implied, including, but not limited to, implied warranties of merchantability and fitness for a particular purpose; provided, however, that implied warranties are not disclaimed during the five-year period from date of purchase. Some states do not allow limitations on how long an implied warranty lasts, so the above limitation may not apply to you.
2. The company shall have no liability hereunder, either direct or contingent, for incidental or consequential damages. Some states do not allow the exclusion or limitation of incidental or consequential damages, so the above limitation or exclusion may not apply to you.
3. This warranty gives you specific legal rights, and you may also have other rights which vary from state to state.
4. These warranties shall be void and shall have no effect:
 - a. If the design or structure of the tank is, or is attempted to be, modified or altered in any way, including, but not limited to, by attaching non-Company approved appliances or equipment.
 - b. If the tank is not properly installed in accordance with all local ordinances and regulations pertinent to tanks and the installation and instruction manual provided with this tank.
 - c. If the pump tank is installed outdoors. This tank is intended for indoor installation only.
 - d. If the tank is not equipped with new pressure protective equipment required by local codes, but not less than a pressure relief valve certified by a nationally recognized testing laboratory that maintains periodic inspection of production of listed equipment or materials, as meeting the requirements for Relief Valves. This valve must be marked with a maximum set pressure not to exceed the marked hydrostatic working pressure of the tank.
 - e. If the tank is not operated within the factory calibrated limits.
 - f. If leaks in the tank, or defects in other parts, arise as the result of improper use, negligence in operation, accident, or from inability of the tank or any of its parts to function because of repairs, adjustments, or replacements improperly made outside the Company's factory, or because of fire, floods or lightning.
 - g. If the model and rating plate has been defaced or discarded and you do not have a Bill of Sale to verify the purchase date.
 - h. If (1) installed in an area where leakage of the tank or connections would result in damage to the area adjacent to the tank or (2) where such a location is unavoidable, a suitable drain pan is not installed under the tank.
 - i. If the tank is used for any purpose other than a pump tank for potable water well applications.
 - j. If the tank is used with pools, whirlpools, or hot tubs, or with any equipment or system that uses heavily chlorinated or otherwise nonpotable water.
 - k. If leaks in the tank or defects in other parts occur as a result of the tank being exposed to a highly corrosive atmospheric condition.
 - l. If leaks in the tank or defects in other parts occur as a result of the tank containing and/or being operated with desalinated (de ionized) water.
 - m. If leaks in the tank or defects in other parts arise as a result of sizing that does not comply with the manufacturer's currently published sizing guides or sizing recommended by the manufacturer.
 - n. If this pump tank or any part has been under water.
 - o. If a new certified pressure relief valve is not installed and properly maintained.
 - p. If the tank is not installed in the United States, its territories or possessions, and Canada;
5. Replacements and/or repairs furnished under these warranties do not carry a new warranty, only the unexpired portion of the original warranty.
6. The terms of this warranty may not be varied by any person, whether or not purporting to represent or to act on behalf of the Company.
7. In order to obtain service under these warranties you must promptly notify the installing contractor or dealer, giving the nature of the problem and the model and serial number of the tank. If for any reason the installer or dealer cannot be located or fails to provide satisfactory warranty service, you should write the Company with the above information.

8. CLAIM PROCEDURE

Any claim under the warranty should be initiated with the dealer who sold the unit, or with any other dealer handling the warrantor's products. If this is not practicable, the owner should contact:

A. O. Smith
500 Tennessee Waltz Parkway
Ashland City, TN 37015
Phone: 1-800-527-1953
www.hotwater.com

- a. The warrantor will only honor replacement with identical or similar tank which are manufactured or distributed by the warrantor.
- b. Dealer replacements are made subject to in-warranty validation by warrantor.
- c. **PROOF-OF-PURCHASE AND PROOF-OF-INSTALLATION DATE ARE REQUIRED TO SUPPORT WARRANTY CLAIM FROM ORIGINAL OWNER. THIS FORM DOES NOT CONSTITUTE PROOF-OF-PURCHASE OR PROOF-OF-INSTALLATION.**

9. DISCLAIMERS

NO EXPRESSED WARRANTY HAS BEEN OR WILL BE MADE ON BEHALF OF THE WARRANTOR WITH RESPECT TO THE MERCHANTABILITY OF THE TANK OR THE INSTALLATION, OPERATION, REPAIR OR REPLACEMENT OF THE TANK. THE WARRANTOR SHALL NOT BE RESPONSIBLE FOR WATER DAMAGE, LOSS OF USE OF THE UNIT, INCONVENIENCE, LOSS OR DAMAGE TO PERSONAL PROPERTY, OR OTHER CONSEQUENTIAL DAMAGE. THE WARRANTOR SHALL NOT BE LIABLE BY VIRTUE OF THIS WARRANTY OR OTHERWISE FOR DAMAGE TO ANY PERSONS OR PROPERTY, WHETHER DIRECT OR INDIRECT, AND WHETHER ARISING IN CONTRACT OR IN TORT. Should governmental regulations or industry standards prohibit the Manufacturer from furnishing a comparable model replacement under this warranty, the Owner will be furnished with the closest comparable tank meeting the then current governmental regulations and industry standards. A supplementary fee may be assessed to cover the additional cost associated with the changes made to meet applicable regulations and standards.

IMPORTANT INFORMATION

Model Number _____ Serial Number _____

INSTALLATION INFORMATION

Date Installed _____ Company's Name _____
Street or P.O. Box _____ City, State, and Zip Code _____
Phone Number _____ Plumber's Name _____

