

Smart Pump Range

Installation, Operation
and Maintenance Manual

 **LOWARA**
a **xylem** brand

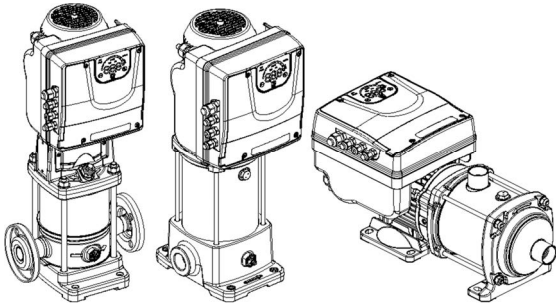

e-SVE

e-VME

e-HME

Applicare qui l'adesivo col codice a barre

Apply the adhesive bar code nameplate here



Table of Contents

1	Introduction and safety	5
1.1	Introduction	5
1.1.1	Qualified personnel.....	5
1.2	Safety.....	5
1.2.1	Safety message levels.....	6
1.3	User safety.....	7
1.4	Inexperienced users	8
1.5	Protecting the environment.....	8
1.6	Warranty	9
1.7	Spare parts	9
1.8	DECLARATION OF CONFORMITY	9
1.8.1	EC Declaration of Conformity (Original)	9
1.8.2	EU Declaration of Conformity (No EMCD19)	9
2	Storage and Transportation	10
2.1	Inspect the package	10
2.2	Storage guidelines.....	10
2.3	Inspect the unit	10
2.4	Transportation guidelines.....	11
2.5	System lifting	11
2.5.1	Lifting diagrams	11
3	Product Description	12
3.1	Systemdescription.....	12
3.2	Product function and use	13
3.3	Applications	13
3.3.1	Actuator (constant speed)	13
3.3.2	Controller (constant pressure).....	13
3.3.3	Cascade serial / Cascade synchronous	13
3.4	Data plates.....	14
3.4.1	Motor.....	14
3.4.2	Pump	15
3.5	Motor technical data	18
3.6	Dimensions and weights.....	19
3.7	Design and layout.....	20
3.8	Pre-assembledexfactorycomponents.....	21
3.9	Optional components	21
4	Mechanical Installation	21
4.1	Installation site checklist	21
4.2	Unit installation	22
4.3	Outdoor installation.....	23

5	Electrical Installation.....	24
5.1	Precautions.....	24
5.2	Electrical requirements	24
5.3	Wire type and ratings	25
5.4	Power supply connection.....	26
6	Operation.....	28
6.1	Discharge time	28
7	Programming	29
7.1	Control panel	29
7.2	Functions of push buttons	30
7.3	LEDs description	30
7.3.1	Power LED.....	30
7.3.2	Status LED.....	30
7.3.3	Speed LED bar	31
7.3.4	Communication LED.....	31
7.3.5	Unit of measure LEDs description	32
7.4	Numeric display	32
7.4.1	Main visualization	32
7.4.2	Parameters menu visualization	33
7.4.3	Multiple pumps priority visualization	33
7.4.4	Alarms and errors visualization	34
7.5	Software parameters	34
7.5.1	Status Parameters	34
7.5.2	Settings Parameters	36
7.5.3	Drive Configuration Parameters	36
7.5.4	Sensor Configuration Parameters	39
7.5.5	RS485 Interface Parameters	40
7.5.6	Multipump Configuration Parameters	40
7.5.7	Test Run Configuration Parameters	41
7.5.8	Special Parameters	41
7.6	Fault finding	41
7.6.1	Alarm codes.....	42
7.6.2	Error codes	42
8	Maintenance	43
8.1	General	43
8.2	Check the functions and parameters.....	43
9	Technical Reference	43
9.1	Example: ACT control mode with analog 0-10V input	43
9.2	Example: Ramp Settings.....	44
9.3	Example: Effective Required Value	45

1 Introduction and safety

1.1 Introduction

Purpose of this manual

The purpose of this manual is to provide necessary information for:

- Installation
- Operation
- Maintenance

CAUTION:

Read this manual carefully before installing and using the product. Improper use of the product can cause personal injury and damage to property, and may void the warranty.

NOTICE:

Save this manual for future reference, and keep it readily available at the location of the unit.

1.1.1 Qualified personnel



WARNING:

This product is intended to be operated by qualified personnel only.

- Correct and reliable transport, storage, installation, operation, and maintenance are required for the trouble-free and safe operation of the frequency converter. Only qualified personnel are allowed to install or operate this equipment.
- Qualified personnel are defined as trained staff, who are authorized to install, commission, and maintain equipment, systems, and circuits in accordance with pertinent laws and regulations. Also, the personnel must be familiar with the instructions and safety measures that are described in this document.

1.2 Safety



WARNING:

- The operator must be aware of safety precautions to prevent physical injury.
 - Unintended rotation of motors creates voltage and can charge the unit, resulting in death, serious injury, or equipment damage. Ensure that motors are blocked to prevent unintended rotation.
 - Operating, installing, or maintaining the unit in any way that is not covered in this manual could cause death, serious personal injury, or damage to the equipment. This includes any modification to the equipment or use of parts not provided by Xylem. If there is a question regarding the intended
 - Do not change the service application without the approval of an authorized Xylem representative.
-



CAUTION:

You must observe the instructions contained in this manual. Failure to do so could result in physical injury, damage, or delays.





1.2.1 Safety message levels

About safety messages

It is extremely important that you read, understand, and follow the safety messages and regulations carefully before handling the product. They are published to help prevent these hazards:

- Personal accidents and health problems
- Damage to the product
- Product malfunction

Definitions

Safety message level	Indication
 DANGER:	A hazardous situation which, if not avoided, will result in death or serious injury
 WARNING:	A hazardous situation which, if not avoided, could result in death or serious injury
 CAUTION:	A hazardous situation which, if not avoided, could result in minor or moderate injury
 Electrical Hazard:	The possibility of electrical risks if instructions are not followed in a proper manner
NOTICE:	<ul style="list-style-type: none"> • A potential situation which, if not avoided, could result in undesirable conditions • A practice not related to personal injury

Hot surface hazard

Hot surface hazards are indicated by a specific symbol that replaces the typical hazard level symbols:



CAUTION:

Magnetic hazard



WARNING:

A strong magnetic field is created when the rotor is removed from or inserted into the motor housing. This magnetic field can be harmful to pacemaker wearers and others with medical implants. In addition, the magnetic field may attract metal parts to the rotor which can cause injuries and/or damage the bearings of the motor.

1.3 User safety

General safety rules

These safety rules apply:

- Always keep the work area clean.
- Pay attention to the risks presented by gas and vapors in the work area.
- Avoid all electrical dangers. Pay attention to the risks of electric shock or arc flash hazards.
- Always bear in mind the risk of drowning, electrical accidents, and burn injuries.

Safety equipment

Use safety equipment according to the company regulations. Use this safety equipment within the work area:

- Hard hat
- Safety goggles, preferably with side shields
- Protective shoes
- Protective gloves
- Gas mask
- Hearing protection
- First-aid kit
- Safety devices

NOTICE:

Never operate a unit unless safety devices are installed. Also see specific information about safety devices in other chapters of this manual.

Electrical connections

Electrical connections must be made by certified electricians in compliance with all international, national, state, and local regulations. For more information about requirements, see sections dealing specifically with electrical connections.

Precautions before work

Observe these safety precautions before you work with the product or are in connection with the product:

- Provide a suitable barrier around the work area, for example, a guard rail.
- Make sure that all safety guards are in place and secure.
- Make sure that you have a clear path of retreat.
- Make sure that the product cannot roll or fall over and injure people or damage property.
- Make sure that the lifting equipment is in good condition.
- Use a lifting harness, a safety line, and a breathing device as required.
- Allow all system and pump components to cool before you handle them.
- Make sure that the product has been thoroughly cleaned.
- Disconnect and lock out power before you service the pump.
- Check the explosion risk before you weld or use electric hand tools.

Precautions during work

Observe these safety precautions when you work with the product or are in connection with the product:

- Never work alone.
- Always wear protective clothing and hand protection.
- Stay clear of suspended loads.
- Always lift the product by its lifting device.
- Beware of the risk of a sudden start if the product is used with an automatic level control.
- Beware of the starting jerk, which can be powerful.
- Rinse the components in water after you disassemble the pump.
- Do not exceed the maximum working pressure of the pump.
- Do not open any vent or drain valve or remove any plugs while the system is pressurized. Make sure that the pump is isolated from the system and that pressure is relieved before you disassemble the pump, remove plugs, or disconnect piping.

- Never operate a pump without a properly installed coupling guard.

Wash the skin and eyes

Follow these procedures for chemicals or hazardous fluids that have come into contact with your eyes or your skin:

Condition	Action
Chemicals or hazardous fluids in eyes	<ol style="list-style-type: none">1. Hold your eyelids apart forcibly with your fingers.2. Rinse the eyes with eyewash or running water for at least 15 minutes.3. Seek medical attention.
Chemicals or hazardous fluids on skin	<ol style="list-style-type: none">1. Remove contaminated clothing.2. Wash the skin with soap and water for at least 1 minute.3. Seek medical attention, if necessary.

1.4 Inexperienced users



WARNING:

This product is intended to be operated by qualified personnel only.

Be aware of the following precautions:

- This product is not to be used by anyone with physical or mental disabilities, or anyone without the relevant experience and knowledge, unless they have received instructions on using the equipment and on the associated risks or are supervised by a responsible person.
- Children must be supervised to ensure that they do not play on or around the product.

1.5 Protecting the environment

Emissions and waste disposal

Observe the local regulations and codes regarding:

- Reporting of emissions to the appropriate authorities.
- Sorting, recycling and disposal of solid or liquid waste.
- Clean-up of spills.

Exceptional sites



CAUTION: Radiation Hazard

Do NOT send the product to Xylem if it has been exposed to nuclear radiation, unless Xylem has been informed and appropriate actions have been agreed upon.

Recycling guidelines

Always follow local laws and regulations regarding recycling.

Waste and emissions guidelines



Do not dispose of equipment containing electrical components together with domestic waste.
Collect it separately in accordance with local and currently valid legislation.

1.6 Warranty

For information about warranty, see the sales contract

1.7 Spare parts



WARNING:

Only use original spare parts to replace any worn or faulty components. The use of unsuitable spare parts may cause malfunctions, damage, and injuries as well as void the guarantee.

For more information about the product's spare parts, refer to the Sales and Service department

1.8 DECLARATION OF CONFORMITY

1.8.1 EC Declaration of Conformity (Original)

Xylem Service Italia S.r.l., with headquarters in Via Vittorio Lombardi 14 - 36075 Montecchio Maggiore VI - Italy, hereby declares that the product:

Electric pump unit with integrated variable speed drive, pressure transmitter and 2-meter cable for pressure transmitter (see label on first page)

fulfills the relevant provisions of the following European directives:

- Machinery 2006/42/EC (ANNEX II - natural or legal person authorised to compile the technical file: Xylem Service Italia S.r.l.)
- Eco-design 2009/125/EC, Regulation (EU) No 547/2012 (Water pump) if MEI marked,

and the following technical standards

- EN 809:1998+A1:2009, EN 60335-1:2012+A11: 2014, EN 60335-2-41:2003+A1:2004+A2:2010, EN 62233:2008
- EN 50598-1:2014, EN 50598-2:2014

Montecchio Maggiore, 22/02/2017

Amedeo Valente

(Director of Engineering and R&D)

rev.01

1.8.2 EU Declaration of Conformity (No EMCD19)

1. Apparatus model/Product:
see label on first page
2. Name and address of the manufacturer:
Xylem Service Italia S.r.l.
Via Vittorio Lombardi 14
36075 Montecchio Maggiore VI
Italy
3. This declaration of conformity is issued under the sole responsibility of the manufacturer.
4. Object of the declaration:
Electric pump unit with integrated variable speed drive, pressure transmitter and 2-meter cable for pressure transmitter
5. The object of the declaration described above is in conformity with the relevant Union harmonisation legislation:
Directive 2014/30/EU of 26 February 2014
(electromagnetic compatibility)
6. References to the relevant harmonised standards used or references to the other technical specifications, in relation to which conformity is declared:
EN 60730-1:2011, EN 61800-3:2004+A1:2012 (Category C2),
EN 55014-1:2006+A1:2009+A2:2011, EN 55014-2:1997+A1:2001+A2:2008, EN 61000-6-2:2005, EN 61000-6-3:2007+A1:2011

7. Notified body: -
8. Additional information:

Signed for and on behalf of: Xylem Service Italia S.r.l.
Montecchio Maggiore, 22/02/2017
Amedeo Valente
(Director of Engineering and R&D) 
rev.01

Lowara is a trademark of Xylem Inc. or one of its subsidiaries.

2 Storage and Transportation

2.1 Inspect the package

1. Inspect the package for damaged or missing items upon delivery.
2. Note any damaged or missing items on the receipt and freight bill.
3. File a claim with the shipping company if anything is out of order.
4. If the product has been picked up at a distributor, make a claim directly to the distributor.

2.2 Storage guidelines

Storage location

The product must be stored in a covered and dry location free from heat, dirt, and vibrations.

NOTICE:

Protect the product against humidity, heat sources, and mechanical damage.

NOTICE:

Do not place heavy weights on the packed product.

NOTICE:

Refer also to par. 3.5 for storage limits.

2.3 Inspect the unit

1. Remove packing materials from the product.
2. Dispose of all packing materials in accordance with local regulations.
3. Inspect the product to determine if any parts have been damaged or are missing.
4. If applicable, unfasten the product by removing any screws, bolts, or straps. For your personal safety, be careful when you handle nails and straps.
5. Contact the local sales representative if there is any issue.

2.4 Transportation guidelines

Precautions



WARNING:

- Stay clear of suspended loads.
- Observe accident prevention regulations in force.
- Do not damage the cables during transport; do not squeeze, bend or drag the cable.
- Always keep the cable ends dry.
- Secure the unit against tipping over and slipping until it is mounted and fixed in its final location.
- Lift and handle the product carefully, using suitable lifting equipment (stacker, crane, crane mounting device, lifting blocks, sling ropes, etc.).
- Always lift the unit by its lifting handle.

2.5 System lifting



WARNING:

Assembled units and their components are heavy. Failure to properly lift and support this equipment can result in serious physical injury and/or equipment damage. Lift equipment only at the specifically identified lifting points. Lifting devices such as eyebolts, slings, and spreaders must be rated, selected, and used for the entire load being lifted.



WARNING: Crush Hazard

1. Always lift the unit by its designated lifting points.
2. Use suitable lifting equipment and ensure that the product is properly harnessed.
3. Wear personal protective equipment.
4. Stay clear of cables and suspended loads.

2.5.1 Lifting diagrams

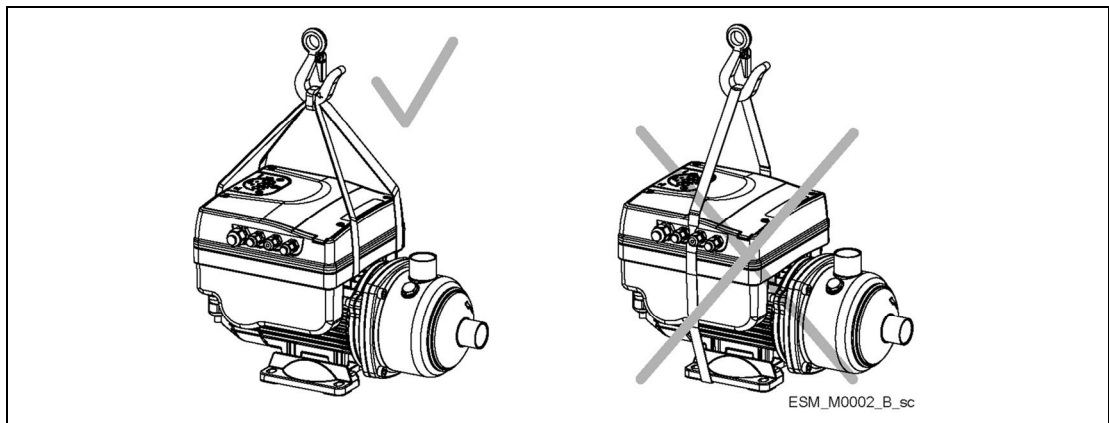

Figure 1: Lifting

3 Product Description

3.1 System description

System layout

Figure 2 and Figure 3 show a typical single-pump and multi-pump system using the unit. When the system is connected directly to the water supply use a low-pressure switch on the suction side.

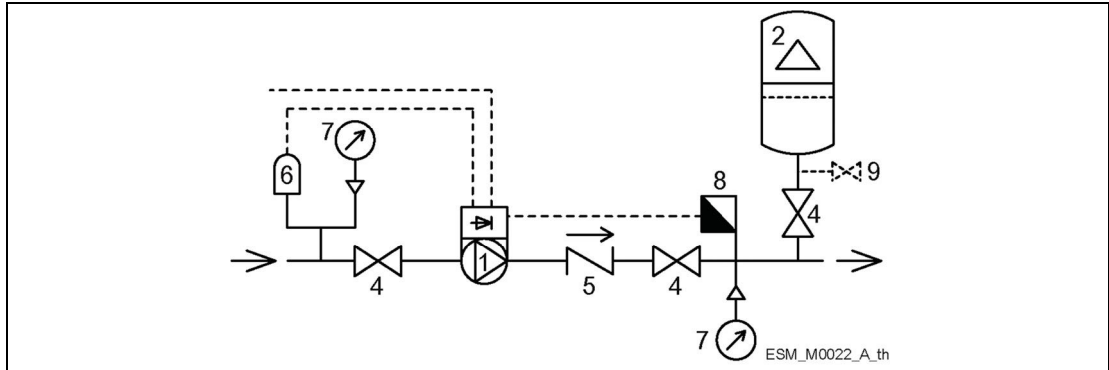

Figure 2: Single-pump system

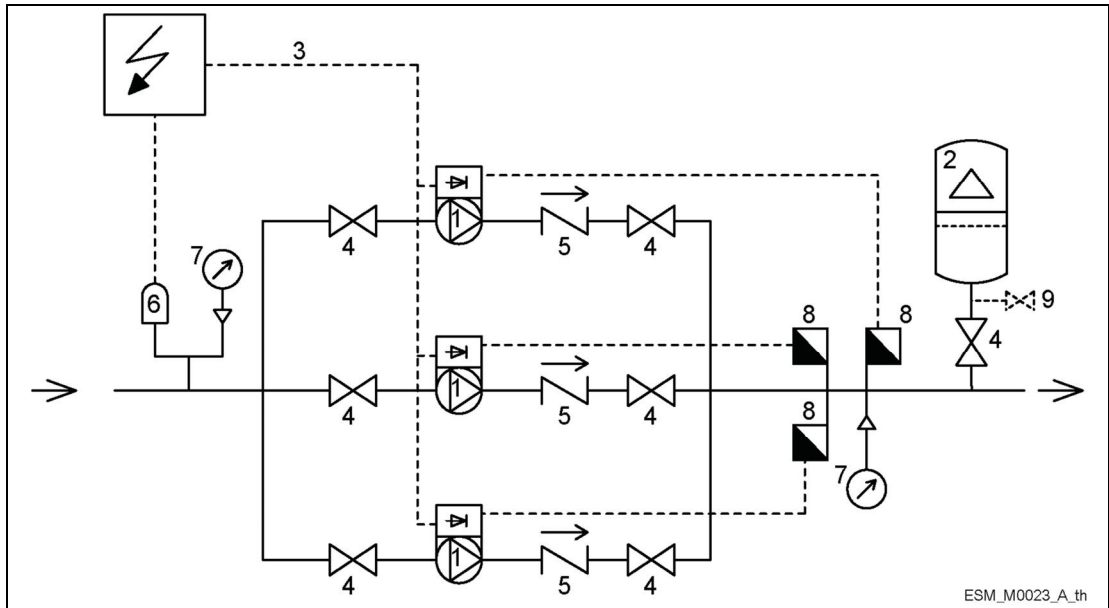

Figure 3: Multi-pump system

- | | | |
|-------------------------------|----------------------|--------------------|
| 1. Pump with e-SM Motor Drive | 4. Gate valve | 7. Pressure gauge |
| 2. Diaphragm pressure tank | 5. Non-return valve | 8. Pressure sensor |
| 3. Distribution panel | 6. Low water control | 9. Drain tap |

Pressure tank

A diaphragm pressure tank is used on the discharge side of the pump to maintain pressure in the pipes when there is no water demand. The unit stops the pump from continuing to run at zero demand and reduce the size of the tank that is required for supply purposes. The tank must be permitted and suitable for systems pressure.

3.2 Product function and use

Description

The product is a vertical/horizontal multistage non self-priming variable speed electropump.

Intended use

The product can be used to pump:

- Cold water
- Hot water

Refer to the standard Installation, Operation and Maintenance Manual for pump design specification.

The variable speed electropumps are made for the following applications:



- Pressure, level, and flow regulation (open loop systems)
- Irrigation applications with single or multiple pumps

Improper use

The product must not be used for closed loop systems.

Approval and certifications

See motor nameplate for approvals:

-  only
-  +  us.

3.3 Applications

The application alternatives for the product are the following:

3.3.1 Actuator (constant speed)

The unit operates as an actuator according to speed set point; this is done through user interface, the corresponding analog input or the communication bus.

3.3.2 Controller (constant pressure)

This mode is set as the default operating mode and is used for a unit in a single pump operation.

3.3.3 Cascade serial / Cascade synchronous

The units are connected via the RS485 interface and communicate via the provided protocol. The combination of the different units which are used in a multi-pump system depends on the system requirements.

It is possible to run all pumps in cascade serial mode and cascade synchronous mode as well. If one unit fails, then each pump of the system can become the lead pump and can take control.

3.4 Data plates

3.4.1 Motor

Motor data plate

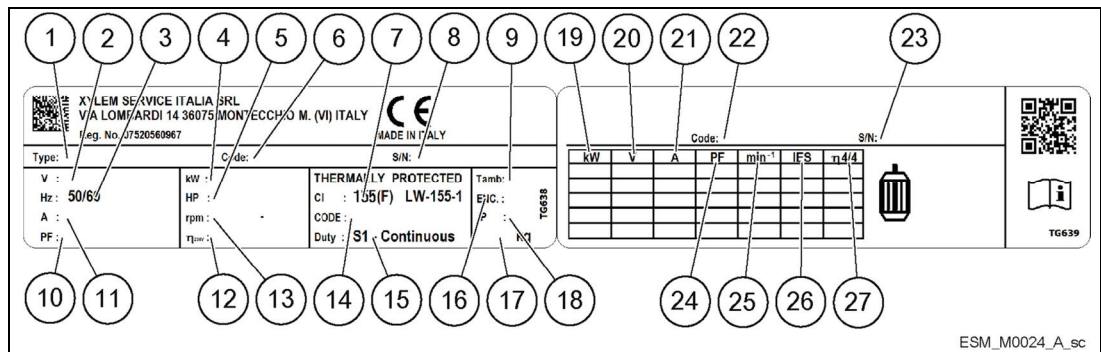

Figure 4: Motor data plate

- | | |
|----------------------------------|-------------------------------------------------------------------|
| 1. Type definition code | 15. Duty type |
| 2. Rated voltage | 16. Enclosure type |
| 3. Rated frequency | 17. Weight |
| 4. Rated power [kW] | 18. Protection class |
| 5. Rated power [HP] | 19. Shaft power |
| 6. Part number | 20. Voltage |
| 7. Insulation class | 21. Current |
| 8. Serial number | 22. Part number |
| 9. Maximum ambient temperature | 23. Serial number |
| 10. Power factor | 24. Power factor |
| 11. Rated current | 25. Speed |
| 12. Motor drive efficiency | 26. Power drive system efficiency class (according to EN 50598-2) |
| 13. Full power speed range | 27. Full load efficiency |
| 14. Code letter for locked rotor | |

Motor type definition code

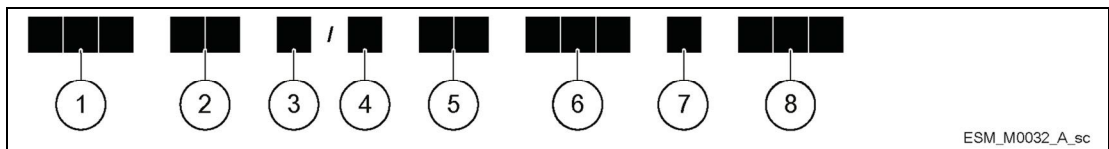

Figure 5: Motor type definition code

- | | |
|----------------------------|----------------------------------------------------------------------------------------------------------------------------------------|
| 1. Series | ESM |
| 2. Motor frame dimension | 90R: Oversized Flange
80: Standard Flange |
| 3. Shaft extension | □□: Standard shaft extension
S8: Custom Shaft extension |
| 4. Power supply | 1: single phase power supply
3: three phase power supply |
| 5. Shaft power*10 [kW] | 03: 0.37kW (0.50HP)
05: 0.55kW (0.75HP)
07: 0.75kW (1.00HP)
11: 1.10kW (1.50HP)
15: 1.50kW (2.00HP)
22: 2.20kW (3.00HP) |
| 6. Motor frame arrangement | SVE: Flange with tapped holes and shaft w/o keyseat
B14: Flange with tapped holes
B5: Flange with free holes |

HMHA: Suitable for 1÷5 e-HM monolithic pumps
 HMHB: Suitable for 1÷5 e-HM w/sleeve pumps
 HMVB: Suitable for 1÷5 e-VM pumps
 HMHC: Suitable for 10÷22 e-HM pumps
 HMVC: Suitable for 10÷22 e-VM pumps
 LNEE: Suitable for In-Line pumps
 56J: Compliant to NEMA 56 Jet standard
 56C: Compliant to NEMA 56C standard

7. Reference market

: Standard
 EU: EMEA

8. Voltage

US: North America
 208-240 : 208-240VAC 50/60Hz
 380-460 : 380-460VAC 50/60Hz
 230/400: 208-240/380-460VAC 50/60Hz

3.4.2 Pump

e-HME/e-VME data plate

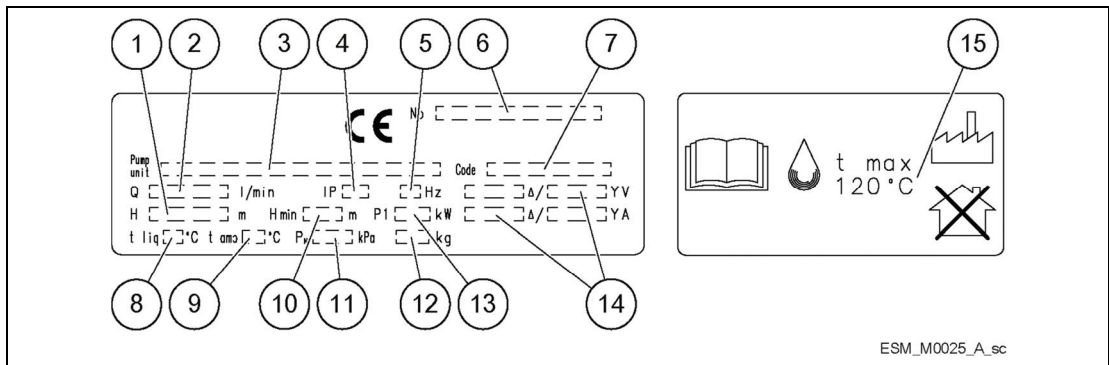

Figure 6: e-HME/e-VME data plate

- | | |
|-----------------------------------------------------------------|-----------------------------------------------------------------------------|
| 1. Head range | 9. Maximum operating ambient temperature |
| 2. Capacity range | 10. Minimum head (EN 60335-2-41) |
| 3. Pump/electric pump unit type definition code | 11. Maximum operating pressure |
| 4. Protection class | 12. Electric pump unit weight |
| 5. Frequency | 13. Electric pump unit absorbed power |
| 6. Serial number (date+progressive number) | 14. Electrical data |
| 7. Electric pump unit/pump part number | 15. Maximum operating liquid temperature (uses other than as EN 60335-2-41) |
| 8. Maximum operating liquid temperature (uses as EN 60335-2-41) | |

e-HME type definition code

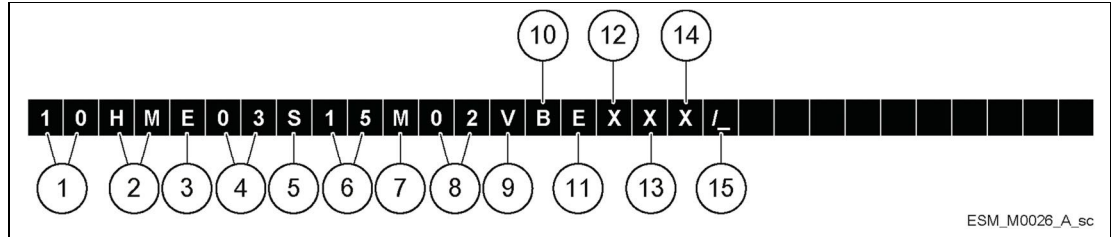

Figure 7: e-HME type definition code

- | | |
|-----------------------|---------------------------------------------------------------------------------------|
| 1. Flow rate | [10] = m ³ /h |
| 2. Series name | [HM] |
| 3. Motor operation | [E] = e-SM |
| 4. Number of impeller | [03] = 3 impellers |
| 5. Material pump | [S] = Stainless steel (AISI 304) |
| 6. Motor power | kW x 10 |
| 7. Phase | [M] = Single-phase
[T] = Three-phase |
| 8. Electrical Voltage | e-SM Power supply
02 = 1x208-240 V
04 = 3x380-460 V
05 = 3x208-240/380-460 V |
| 9. Rotating part | [Q] = Silicon Carbide (Q ₁)
[V] = Aluminium oxide (Ceramic) |
| 10. Stationary part | [Q] = Silicon Carbide (Q ₁)
[B] = Carbon resin impregnated |
| 11. Elastomers | [E] = EPDM
[V] = FPM
[K] = FFPM (Kairez®) |
| 12. | Null = None
Z = other |
| 13. | Null = None |
| 14. Connections | Null = Threaded |
| 15. | Null or letter assigned by the manufacturer |

e-VME type definition code

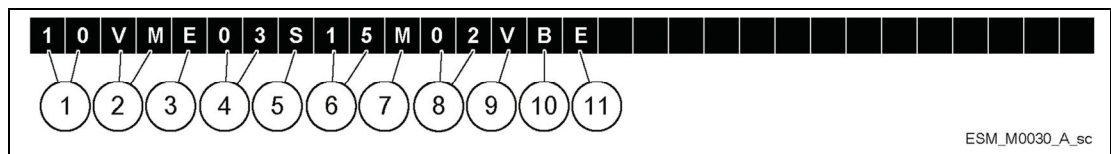

Figure 8: e-VME type definition code

- | | |
|-----------------------|---------------------------------------------------------------------|
| 1. Flow rate | [10] = m ³ /h |
| 2. Series name | [VM] |
| 3. Motor operation | [E] = e-SM |
| 4. Number of impeller | [03] = 3 impellers |
| 5. Material pump | [P] = Stainless steel AISI 304 with Noryl™ impellers |
| 6. Motor power | kW x 10 |
| 7. Phase | [M] = Single-phase electric pump
[T] = Three-phase electric pump |
| 8. Electrical Voltage | [2] = 1x208-240 V
[4] = 3x380-460 V
[5] = 3x208-240/380-460 V |
| 9. Rotating part | [V] = Aluminium oxide (Ceramic) |
| 10. Stationary parts | Carbon resin impregnated |
| 11. Elastomers | [E] = EPDM |

e-SVE data plate

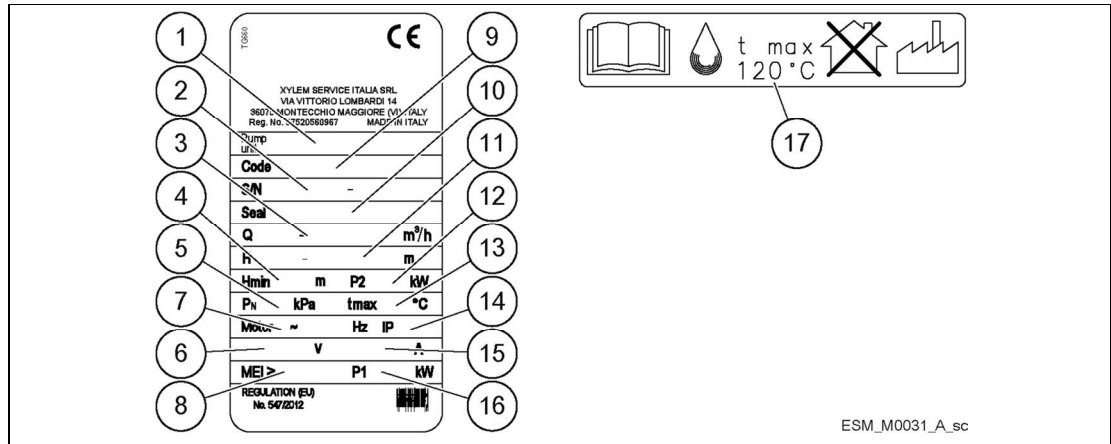

Figure 9: e-SVE data plate

- | | |
|--------------------------------------------|-----------------------------------------------------------------------------|
| 1. Pump/electric pump unit type | 10. Mechanical seal material identification code |
| 2. Serial number (date+progressive number) | 11. Head range |
| 3. Capacity range | 12. Motor nominal power |
| 4. Minimum head (EN 60335-2-41) | 13. Maximum operating liquid temperature (uses as EN 60335-2-41) |
| 5. Maximum operating pressure | 14. Protection class |
| 6. Rated voltage range | 15. Current |
| 7. Frequency | 16. Electric pump unit absorbed power |
| 8. Minimum efficiency index | 17. Maximum operating liquid temperature (uses other than as EN 60335-2-41) |
| 9. Electric pump unit/ pump part number | |

e-SVE type definition code

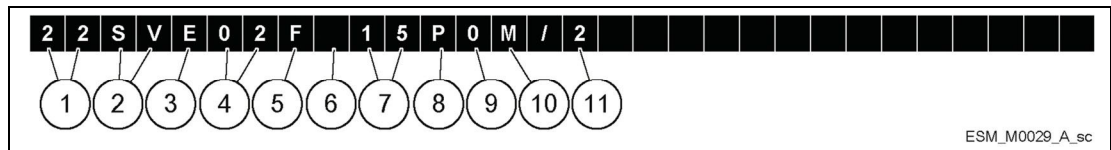

Figure 10: e-SVE type definition code

- | | |
|------------------------|---------------------------------------------------------------------------------------------------------------------------------------------------------------------------------------------------------------------------------------------------------------|
| 1. Flow rate | [22] = m ³ /h |
| 2. Series name | [SV] |
| 3. Motor operation | [E] = e-SM |
| 4. Number of impeller | [02] = 2 impellers |
| 5. Material pump | [F] = Stainless steel AISI 304, round flanges (PN 25)
[T] = Stainless steel AISI 304, oval flanges (PN 16)
[R] = Stainless steel AISI 304, discharge port above suction, round flanges (PN 25)
[N] = Stainless steel AISI 316, round flanges (PN 25) |
| 6. Version | Null = standard version |
| 7. Motor power | kW x 10 |
| 8. Poles | [P] = e-SM |
| 9. Frequency | [0] = e-SM |
| 10. Phase | Null = pump
[M] = Single-phase electric pump
[T] = Three-phase electric pump |
| 11. Electrical Voltage | [2] = 1x208-240 V
[4] = 3x380-460 V
[5] = 3x208-240/380-460 V |

3.5 Motor technical data

Table 1: Electrical, Environmental and Installation specifications

	e-SM Drive model										
	103	105	107	111	115	303	305	307	311	315	322
Input											
Input frequency [Hz]	50/60 ± 2										
Mains supply	LN					L1 L2 L3					
Nominal input voltage [V]	208÷240 ±10%					208÷240 / 380÷460 ±10%					380÷460 ±10%
Max. Input Current Continuous [A]	2,3	3,3	4,4	6,3	8,6	-	-	-	-	-	-
PDS Efficiency Class	IES2										
Output											
Min÷Max Speed [rpm]	800÷3600										
Leakage Current [mA]	< 3,5										
I/O auxiliar + 15VDC power supply [mA]	I _{max} < 40										
Fault signal relay	1 x NO V _{max} < 250 [VAC] , I _{max} < 2 [A]					2 x NO V _{max} < 250 [VAC] , I _{max} < 2 [A]					
EMC (Electro Magnetic Compatibility)	See par.1.8 DECLARATION OF CONFORMITY. Installations must be done according to EMC good practice guidelines (e.g. avoiding pigtailed on drive side)										
Sound Pressure LpA [dB(A)]	< 62 @3000 [rpm] <66 @3600 [rpm]										
Insulation class	Class 155 F										
Enclosure Rate	IP 55, Enclosure Type 1 Protect the product from direct sunlight and rainfall										
Relative humidity (storage & operating)	5% ÷ 95% RH										
Storage temperature [°C] /[°F]	-25÷65 / -13÷149										
Operating temperature [°C] /[°F]	-20÷50 / -4÷122										
Air Pollution	Pollution Degree 2										
Altitude	Max. 1000 [m] /3280 [feet] above sea level. For installation over 1000 [m] above sea level de-rating may occur										

3.6 Dimensions and weights

Reading instructions

Drawings show dimensions only in millimeters.
The images are not to scale.

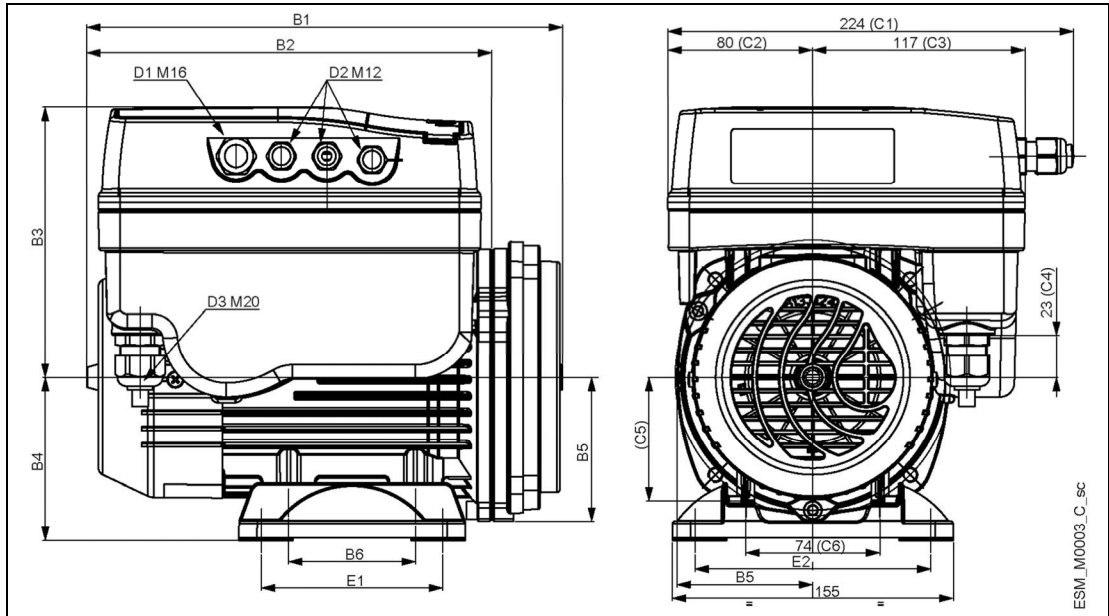

Figure 11: Dimensions

Table 2: Dimensions and weights

Model	Net weight (stack length + drive) [kg]		B1	B2	B3	B4	B5	B6	C1	C2	C3	C4	C5	C6	D1	D2	D3	E1	E2	
	103, 105, 107	111, 115																		
	[mm]																			
ESM90R...LNEE	7.4	8.9	376			-	79											-	-	
ESM 90RS8...LNEE	7.3	8.8	343			-	79											-	-	
ESM90R...B14-SVE	7.5	9	292			-	79											-	-	
ESM90R...B5	7.5	9	292			-	100											-	-	
ESM80...HMHA	7.5	9	263			90	79											100	125	
ESM80...HMHA US																				
ESM80...HMHA EU																				
ESM80...HMHB	7.6	9.2	268			90	80											100	125	
ESM80...HMHB US																				
ESM80...HMHB EU																				
ESM80...HMVB	7.4	8.9	268	224	149		80	70	224	80	117	23	68	74	M16	M12				
ESM80...HMVB US																				
ESM80...HMVB EU																				
ESM80...HMHC	7.9	9.4	272			90	91											100	125	
ESM80...HMHC US																				
ESM80...HMHC EU																				
ESM80...HMVC	7.6	9.1	272				91													
ESM80...HMVC US																				
ESM80...HMVC EU																				
ESM80...BG	7.3	8.8	282			-	108											-	-	
ESM90R...56J	7.5	9.1	307			89	83											NPT	76	124
ESM90R...56C	7.2	8.8	294			-	83											1/2"	-	-

... = 103, 105, 107, 111, 115
Blank cell = motor foot is missing

Free distance

Table 3: Free distance

Area	e-SM Drive model	Free Distance
Above the unit	103..105..107..111..115	> 260mm (10.2 in)
Center-distance between units (to ensure space for cabling)	103..105..107..111..115	> 260mm (10.2 in)
	303..305..307..311..315..322	≥ 300mm (11.8 in)

3.7 Design and layout

Parts and descriptions

The unit can be fitted with the features the application requires.

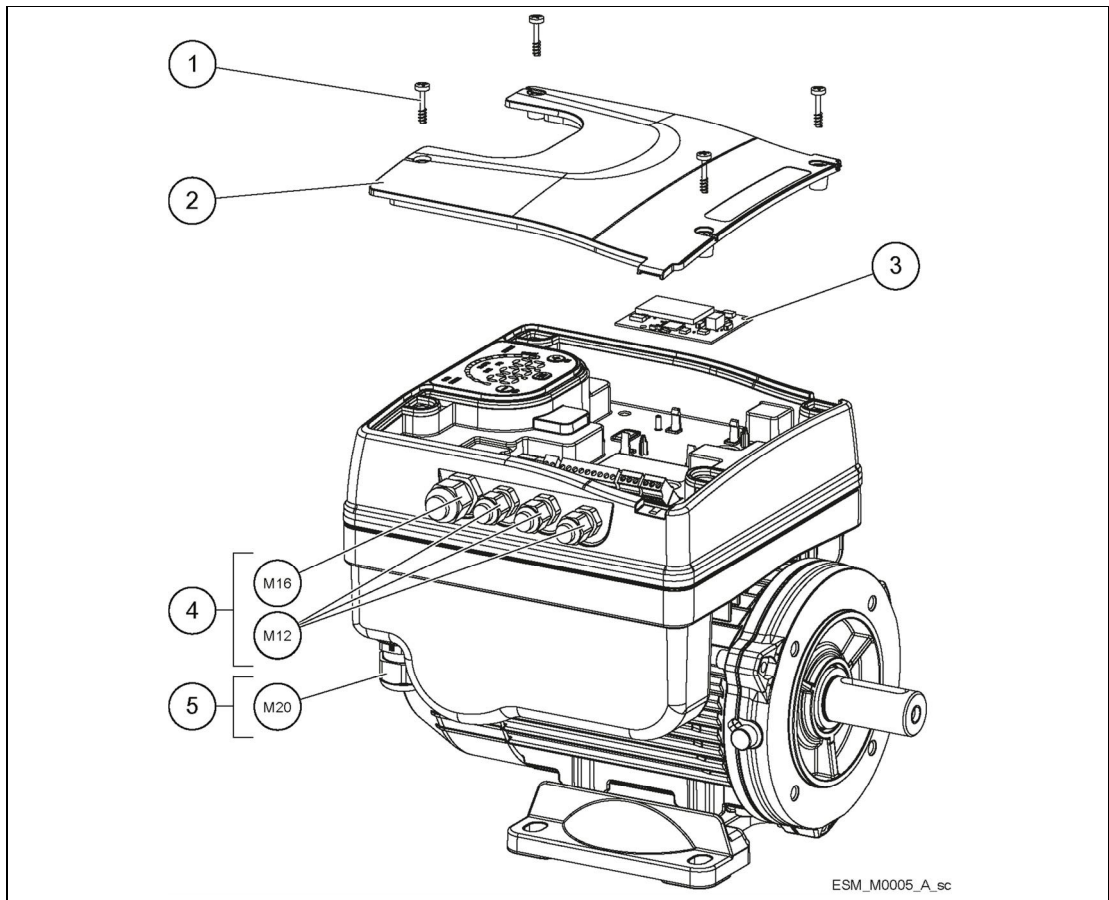

Figure 12: Open terminal box cover on drive models 103, 105, 107, 111, 115

Table 4: Part description

Position number	Description	Tightening torque	
		[Nm]	[in•lbs]
1	Captive Screws	1.2	11
2	Terminal Box Cover	-	-
3	Optional module with strip	-	-
4	IO Cable gland M12 (3x) / M16 (1x)	0.7/2	6.4/18.3
5	M20 Power cable gland	2.7	24.75

3.8 Pre-assembled ex factory components

Table 5: Included components

Included components		Cable Outer Diameter		e-SM Drive model	
		[mm]	[inches]	103, 105, 107, 111, 115	303, 305, 307, 311, 315, 322
Cable Gland(s) and Lock Nut(s)	M12	3.7 ÷ 7.0	0.145 ÷ 0.275	3	3
	M16	4.5 ÷ 10.0	0.177 ÷ 0.394	1	1
Cable Gland	M20	7.0 ÷ 13.0	0.275 ÷ 0.512	1	1
Plug(s) for Cable Gland(s)	M12	included		3	3
	M16	included		1	1
	M20	included		1	1

3.9 Optional components

Table 6: Optional components

Component	Description
Sensors	The following sensors can be used with the unit: <ul style="list-style-type: none"> Level-sensor
RS485 Module	To connect and interact by wire with e-SM Drive
Wireless Module	To connect and interact wireless with e-SM Drive
Adaptor	M20 Metric to 1/2" NPT Adapter (item is always supplied for US market)

4 Mechanical Installation

4.1 Installation site checklist



DANGER:

Never install the unit in an explosive or flammable environment.



WARNING:

- Always refer to the local and national regulations, legislation, and codes in force regarding selection of installation site, and water and power connections.
 - Keep the manual, drawings, and diagrams accessible for detailed installation and operation instructions. It is important that the manual is available for equipment operators.
 - Ensure that the ingress protection rating of the Unit (IP 55, Type 1) is suitable for the installation environment.
-



CAUTION:

- Ingress protection. IP55 (Type 1) rating can only be guaranteed if the unit is properly closed.
- Make sure that there is no liquid on the unit before opening the plastic cover.
- Ensure all cable glands and unused holes for glands are properly sealed.
- Ensure that the plastic cover is properly closed.
- Device damage through contamination. Do not leave unit without the Terminal Box Cover.

4.2 Unit installation

Install the unit according to the systems liquid flow.

- Usually arrows on the pump housing show flow and rotating direction.
- The standard rotating direction for the unit is Clockwise (seen from fan cover). For more information contact Service.
- The unit must be installed according to Figure 13.
- Always install a backflow-prevention device on the delivery side.
- Always install downstream the pressure transmitter (if any) supplied.

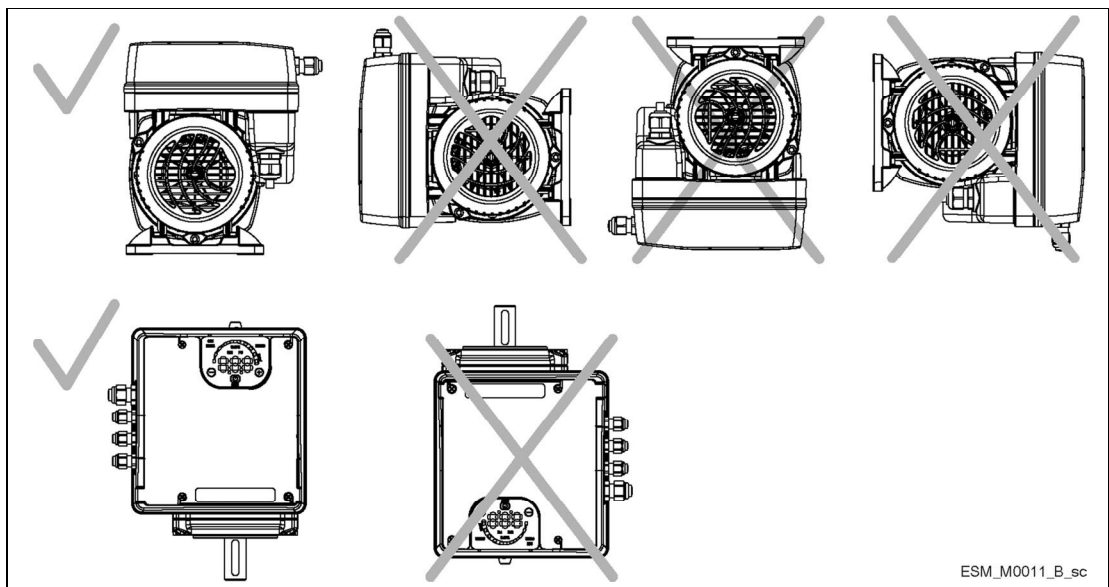

Figure 13: Unit installation

4.3 Outdoor installation

When the unit is installed outdoors a suitable cover must be provided. See Figure 14.

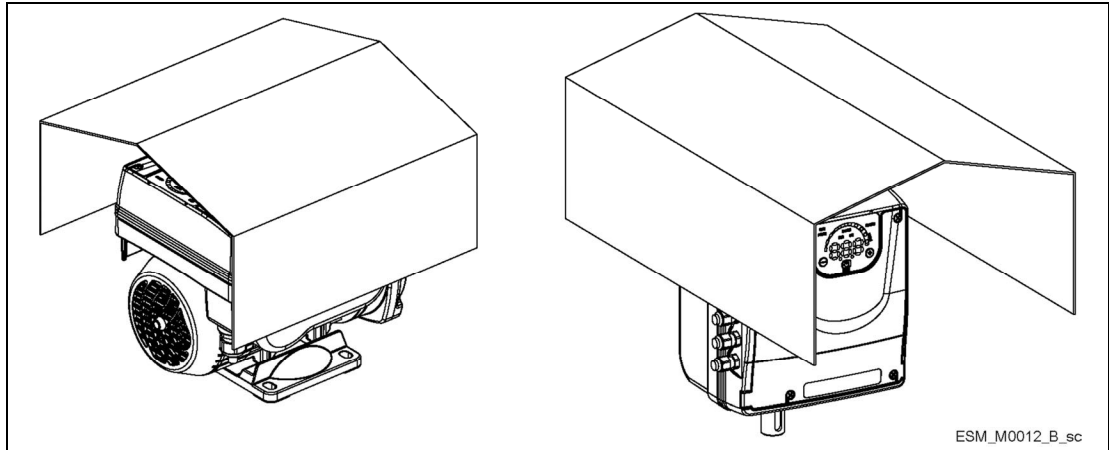

Figure 14: Outdoor installation

The cover must be sized to ensure that the motor is not exposed to snow, rain or direct sunlight. When fitting a cover to the motor, observe the guideline in section 3.6, table 4.

5 Electrical Installation

5.1 Precautions



WARNING:

- **EQUIPMENT HAZARD.** Rotating shafts and electrical equipment can be hazardous. All electrical work must conform to national and local electrical codes. Installation, start-up, and maintenance must be performed by trained and qualified personnel. Failure to follow these guidelines could result in death or serious injury.
-



Electrical Hazard:

- All electrical wiring must be carried out by an authorized electrician, in accordance with the electrical regulations locally in force.
-

5.2 Electrical requirements

The local regulations in force overrule specified requirements listed below.

Electrical connection checklist

Check that the following requirements are met:

- The electrical leads are protected from high temperature, vibrations, and collisions.
- The current type and voltage of mains connection must correspond to the specifications on the data plate on the pump.
- The power supply line is provided with:
- A high-sensitivity differential switch (30 mA) [residual current device RCD] suitable for earth fault currents with DC or pulsating DC content (a Type B RCD is suggested).
- A mains isolator switch with a contact gap of at least 3 mm.

The electrical control panel checklist

NOTICE:

The control panel must match the ratings of the electric pump. Improper combinations could fail to guarantee the protection of the unit.

Check that the following requirements are met:

- The control panel must protect the pump against short-circuit. A time lag fuse or a circuit breaker (Type C model is suggested) can be used to protect the pump.
 - The pump has built in overload and thermal protection, no additional overload protection is required.
-



Electrical Hazard:

Before starting work on the unit, make sure that the unit and the control panel are isolated from the power supply and cannot be energized.

Grounding (earthing)



Electrical Hazard:

Always connect the external protection conductor to ground (earth) terminal before making other electrical connections.

All electrical equipment must be ground (earth) connected. This applies to the pump unit and related equipment. Verify the pump ground terminal is earthed.

- Keep the ground wire connections as short as possible.
- Use high-strand wire to reduce electrical noise is recommended.

5.3 Wire type and ratings

- All wiring must comply with local and national regulations regarding cross section and ambient temperature requirements.
- Use cables with a minimum heat resistance of +70 °C (158 °F); to obey the UL (Underwriters Laboratories) regulations, it is recommended that all power connections be made with a minimum 75°C rated copper wire of the following types: THW, THWN.
- The cables never have to touch the motor housing or the pump or the pipeline.
- Wires connected to supply terminals and fault signal relay (NO,C) must be separated from others by reinforced insulation.

Table 7: Recommended power connections cables

e-SM Drive models	Power supply input cable + PE		Tightening torque	
	Wire numbers x Max. copper section	Wire numbers x Max. AWG	Mains and motor cable terminals	Earth Conductor
103, 105, 107, 111, 115	3 x 1.5 mm ² 3 x 0.0023 sq.in	3 x 15 AWG	Spring connectors	Spring connectors
303, 305, 307, 311, 315, 322	4 x 1.5 mm ² 4 x 0.0023 sq.in	4 x 15 AWG	0.8 Nm 7.1 lb-in	3 Nm 26.6 lb-in

Control cables

External volt free contacts must be suitable for switching < 10 VDC.

NOTICE:

Control cables must be installed separate both from power supply cable and fault signal relay cable. If control cables are installed in parallel to power supply cable or fault signal relay cable for a longer distance, the distance between these cable should be more than 200 mm. Do not cross power cables. If this is not possible, cross them only in a an angle of 90°.

Table 8: Recommended control cables

e-SM Drive control cables	Wires number x Max. copper Section	AWG	Tightening torque
All I/O conductors	0.75÷1.5 mm ² 0.00012÷0.0023 sq.in	18÷16 AWG	0.6 Nm 5.4 lb-in

5.4 Power supply connection



WARNING:

Do not make any connection in the pump control box unless the power supply has been switched off for at least 2 minutes.

Table 9: Power supply wiring procedure

	Reference Figure	
	e-SM Drive models 103, 105, 107, 111, 115	e-SM Drive models 303, 305, 307, 311, 315, 322
1. Open the terminal box cover, remove the screws (1) 2. Use the M20 cable gland for the power cable.	Fig. 12	-
3. Connect the cable according to the wiring diagram. 4. Connect the ground (earth) lead. Make sure that the ground (earth) lead is longer than the phase leads. 5. Connect the phase leads.	Fig. 15 Fig. 16	-
6. Close the terminal box cover and tight the screws.	Fig. 12	-

Table 10: I/O wiring procedure

	Reference Figure	
	e-SM Drive models 103, 105, 107, 111, 115	e-SM Drive models 303, 305, 307, 311, 315, 322
1. Open the terminal box cover, remove the screws (1)	Fig. 12	-
2. Connect the cable according to the wiring diagram.	Fig. 15 Fig. 16	-
3. Follow additional requirements of table 13		
4. Close the terminal box cover and tight the screws.	Fig. 12	-

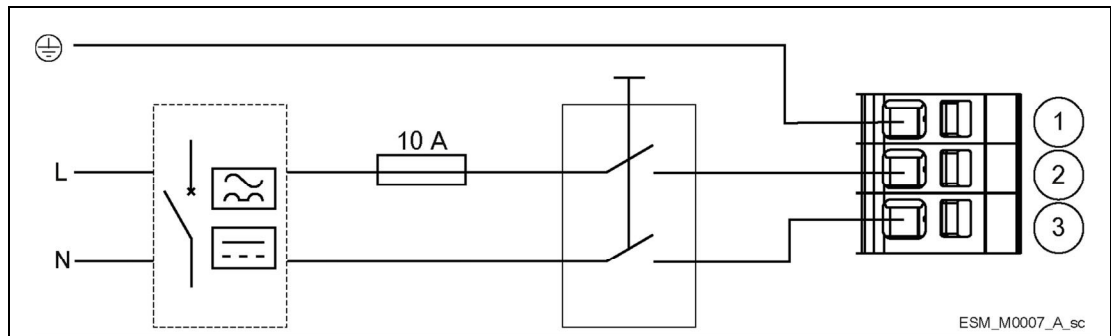

Figure 15: Wiring diagram

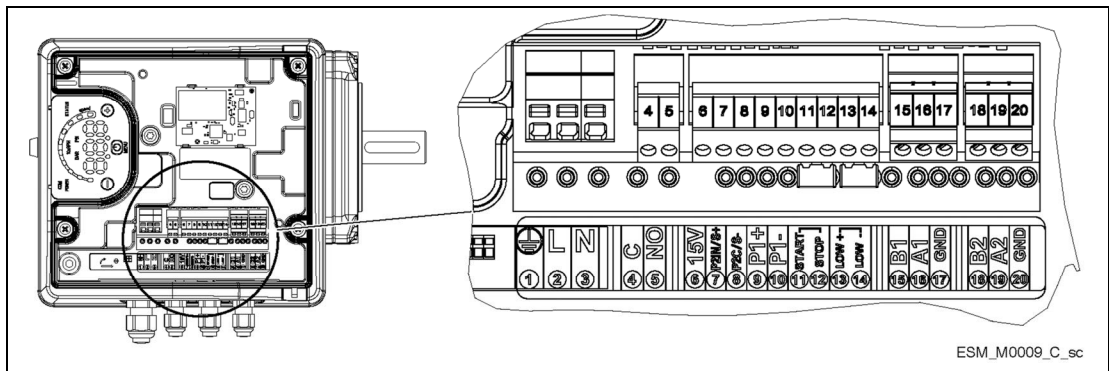

Figure 16: Connection label

Table 11: I/O terminals

Item	Terminals	Number	Description	Comments
Fault Signal	C	4		In case of Power Wires: use M20 cable gland
	No	5		
Auxiliary Voltage Supply	15V	6	Voltage Supply	15VDC, Σ max. 100mA
Analog 0-10V	P2IN/S+	7	Actual value voltage	0÷10 VDC
	P2C/S-	8	Ground for external sensor or external speed control	GND, electronic ground (for S+)
External Pressure sensor [also Differential]	P1+	9	Voltage Supply	15VDC, Σ max. 100mA
	P1-	10	Actual value current	4÷20 mA
External Start/Stop	START	11	External ON/OFF input	Default short circuited. Pump is enabled to RUN
	STOP	12	Ground for external ON/OFF input	
External Lack of Water	LOW+	13	External Lack of Water	Default short circuited. Lack of Water Detection: enabled
	LOW-	14	Ground for External Lack of Water	
Communication Bus	B1	15	RS485 port 1: RS485 -1N	ACT, HCS control mode: RS 485 port1 for external communication MSE, MSY control mode: RS 485 port1 for multi-pump systems
	A1	16	RS485 port 1: RS485 -1P	
	GND	17	GND, electronic ground	
Communication Bus	B2	18	RS485 port 2: RS485 -2N	RS 485 port2 for external communication
	A2	19	RS485 port 2: RS485 -2P	
	GND	20	GND, electronic ground	

6 Operation

In case of co-existence of two or more of the following conditions:

- high ambient temperature
- high liquid temperature
- duty points insisting on unit maximum power
- persisting undervoltage of mains,

life expectancy of the unit may be affected and/or derating may occur: contact your Sales and Service Department for more information.

6.1 Discharge time



WARNING:

Disconnect and lock out electrical power and wait for the minimum waiting time specified below. Failure to wait the specified time after power has been removed before performing service or repair could result in death or serious injury.

Frequency converters contain DC-link capacitors that can remain charged even when the frequency converter is not powered. To avoid electrical hazards, disconnect:

- AC mains
- Any permanent magnet type motors
- Any remote DC-link power supplies, including battery backups, ups and DC-link connections to other frequency converters.

Wait for the capacitors to discharge completely before performing any service or repair work. Refer to the table 12 for wait times.

Table 12: Wait times

e-SM Drive model	Minimum waiting times (min)
103, 105, 107, 111, 115	4
303, 305, 307, 311, 315, 322	

7 Programming

Precautions

NOTICE:

Read and follow the operating instructions carefully before you start programming. This is to prevent incorrect settings which cause malfunction. All modifications must be done by qualified technicians.

7.1 Control panel

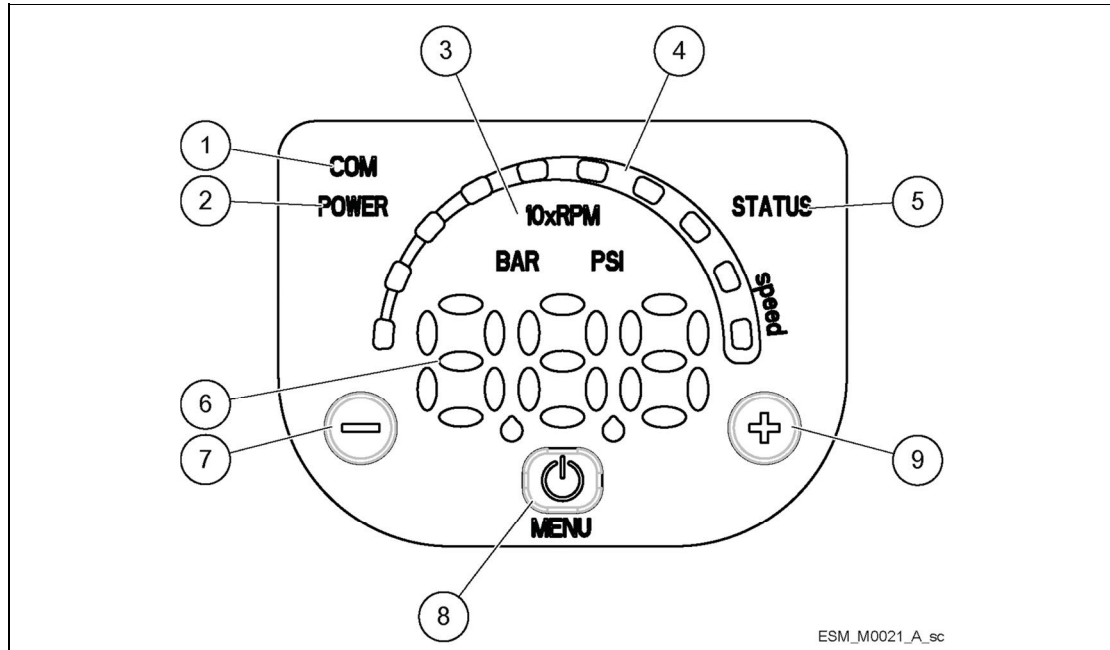













Figure 17: Control panel

Table 13: Part description

Position number	Description	See paragraph
1	Communication LED	7.3.4
2	Power LED	7.3.1
3	Unit of measure LEDs	7.3.5
4	Speed LED bar	7.3.3
5	Status LED	7.3.2
6	Numeric display	7.4
7	 button	7.2
8	 button	7.2
9	 button	7.2

7.2 Functions of push buttons

Table 14: Functions of push buttons

Push button	Function
	<ol style="list-style-type: none"> 1. Main Visualization (see par. 7.4.1): decrease the required value related to the selected control mode. 2. Parameters Menu Visualization (see par. 7.4.2): decrease the parameter index visualized. 3. Parameters Editing/Visualization (see par. 7.4.2): decrease the displayed parameter value. 4. Zero Pressure Autocalibration (see par. 7.5, P44): perform autocalibration of pressure sensor.
	<ol style="list-style-type: none"> 1. Main Visualization (see par. 7.4.1): increase the required value related to the selected control mode 2. Parameters Menu Visualization (see par. 7.4.2): increase the displayed parameter index. 3. Parameters Editing/Visualization (see par. 7.4.2): increase the parameter value. 4. Zero Pressure Autocalibration (see par. 7.5, P44): perform autocalibration of pressure sensor.
	<ol style="list-style-type: none"> 1. Main Visualization (see par. 7.4.1): START/STOP the pump 2. Parameters Menu Visualization (see par. 7.4.2): switch to Parameters Edit Visualization. 3. Parameters Edit Visualization (see par. 7.4.2): save the parameter value.
 long press	Main Visualization (see par. 7.4.2): switches to Parameter Selection. Parameters Menu Visualization: switches to Main Visualization
 and 	Main Visualization: switch between units of measure Speed and Head (see par. 7.4.1).
 and 	Main Visualization: switch between units of measure Speed and Head (see par. 7.4.1).

7.3 LEDs description

7.3.1 Power LED

When the **POWER** (green) LED is lit, the pump is supplied with power and the electronic devices are operative.

7.3.2 Status LED

- If the STATUS LED is not lit, then the pump is stopped or disabled (the pump motor is not running).
- If the **STATUS** (green) LED is lit, then the pump is running
- If the **STATUS** (orange) LED is lit a non-blocking alarm is detected while the pump is stopped.
- If the **STATUS** (orange) LED is lit alternate with **STATUS** (green), a non-blocking alarm is detected while the pump is running.
- If the **STATUS** (red) LED is lit, a blocking error is detected and the pump is stopped (the pump motor is not running).

7.3.3 Speed LED bar

The Speed LED bar, is composed by 10 LEDs and each of them represents a % step (from 10% to 100%) of the interval, between the absolute minimum (P27) and maximum (P26) speed parameters values.

LEDs are lit if motor is running and its speed reaches the specific % step represented by each of them.

If motor is running and its speed is lower than the absolute minimum (P27), the first LED blinks.

When motor is stopped, all arc's LEDs are switched off.

7.3.4 Communication LED

The way the COM LED is lit (permanently) or blinks, depends on several settings and conditions as below.

Condition 1

If no optional communication module is used and the protocol for the communication bus is Modbus RTU (parameter P50 is set to value "Modbus"):

- If the COM LED is not lit, then the drive cannot detect any valid Modbus message on the terminals provided for the communication bus
- If the COM (green) LED is permanently lit, then the drive both detected a communication bus on the provided terminals acknowledged the correct addressing
- If the COM (green) LED is blinking with 50% duty every second, then the drive detected a communication bus on the provided terminals has not been correctly addressed.

Particular behaviors (in this condition) for this LED are the following:

- If the COM (green) LED switches from being permanently lit to being not lit, then the drive didn't detect any valid Modbus RTU message (at least) for the last 5 seconds
- If the COM (green) LED switches from being permanently lit to blinking with 50% duty every second, then the drive has not been correctly addressed (at least) for the last 5 seconds.

Condition 2

If no optional communication module is used and the protocol for the communication bus is Bacnet MSTP (parameter P50 is set to value "Bacnet"):

- If the COM LED is not lit, then the drive didn't receive any valid request, coming from any other Bacnet MSTP device, (at least) for the last 5 seconds
- If the COM (green) LED is permanently lit, then the drive is exchanging information with any other Bacnet MSTP device.

Condition 3

If no optional communication module is used and a Multipump control mode is selected (Ex. MSE or MSY):

- If the COM LED is not lit, then the drive didn't receive any valid request, coming from other pumps through the Multipump BUS, (at least) for the last 5 seconds
- If the COM (green) LED is permanently lit, then the drive is exchanging information with other pump through the Multipump BUS.

Condition 4

If the optional communication module is used:

- If the COM LED is not lit, then the connection with the wireless module is damaged or absent
- If the COM (green) LED is blinking with 10% duty every second, then the drive is exchanging information with the communication module.

7.3.5 Unit of measure LEDs description

Speed

When Speed (pump impeller speed) is the measurement selected:

- The current rotation speed measure [expressed as revolutions per minute divided by 10] is displayed on the numeric display □
- The **10xRPM** LED is lit.

Head

When Head (hydraulic water head) is the measurement selected:

- The current water head measured expressed in BAR (or PSI) of water head, (dependent from P41 value, see par. 7.5.4) is displayed on the numeric display □
- The **BAR** (or **PSI**) LED is lit.

7.4 Numeric display

7.4.1 Main visualization

Off mode

OFF is visualized when the contacts [11,12] (see par. 5.5) are not short circuited. Off mode, has lower visualization priority than Stop mode.

Stop mode

STP is visualized when the pump is manually stopped.

If the pump is powered-on having previously set P04 = Off (see par. 7.5.1), pump is stopped so pump motor is not running and STP blinks (**STP** → **STP**).

To manually stop the pump, follow next examples:

- Example 1 (valid for HCS, MES, MSY control modes with an initial required value (Head) of 4.20 [BAR] and a minimum value of 0.5 [BAR]):

BAR 420 →  single press → **STP**.

- Example 2 (valid for ACT control mode with an initial required (Speed) value of 200 [10xRPM] and a minimum value of 80 [10xRPM]):

10xRPM 200 →  single press → **STP**.

Running mode

ON is visualized for few seconds, when the contacts [11,12] are short circuited and the pump is not in Stop Mode.

This visualization indicates that the pump is switched on and the motor shall start (dependently from selected control mode).

To manually set the pump to Running Mode, follow next examples:

- Example 1 (valid for HCS, MES, MSY control modes reaching a required value (Head) of 4.20 [BAR] by starting with a minimum value of 0.5 [BAR], after a manual stop):





STP →  single press → **ON** → after few seconds... → **420 BAR**.

- Example 2 (valid for ACT control mode reaching a required value (Speed) of 200 [10xRPM] by starting with a minimum value of 80 [10xRPM] , after a manual stop):





STP →  single press → **ON** → after few seconds... → **200 10xRPM**.

While pump is running, both Actual Head and Actual Speed can be shown by Numeric display [6] as in the following examples:

- Example 3 (valid for HCS, MES, MSY control modes with an Actual Head of 4.20 [BAR] and a corresponding Actual Speed of 352 [10xRPM]):

BAR 420 →  +  → **352 10xRPM** → after 10 seconds or  +  → **420 BAR**.

- Example 4 (valid for ACT control mode with an Actual Speed of 200 [10xRPM] and a corresponding Actual Head of 2.37 BAR):

10xRPM 200 →  +  → **237 BAR** → after 10 seconds or  +  → **200 10xRPM**.

7.4.2 Parameters menu visualization

This menu allows the selection of all drive's parameters (see par. 7.5) and the access (see par. 7.2) to the Parameters Editing/Visualization for each of them.

Power on

After power on, accessing to Parameters Menu Visualization, if parameter P23 = ON, the Numeric display [6] shows P20 blinking as follow (see par. 7.2 and par. 7.5.1):

P20 → **P20**

Input password is required to unlock parameters visualization and editing.

Password timeout

If P23 = ON and no buttons are pressed for more than 10 minutes after last Parameters Menu Visualization accessing (see par. 7.2), the parameters visualization and editing will be locked. Still input password is required to unlock parameters visualization and editing.

Parameters Menu

If P23 = OFF or after inputs correct password (P20), parameters visualization and editing will be unlocked.

Accessing to the Parameters Men, the Numeric display [6] shows:

P01 → **P01**
P02 → **P02**

...
P69 → **P69**

Parameter's index blinks to indicate the possibility of parameter selection.

Parameters Editing / Visualization

Accessing to a parameter's value, If the parameter is both readable and writable, its value can be changed using the push buttons or trough communication protocol (Modbus or BACnet).

Going back to Parameters Menu, the index of visualized parameter is automatically increased.

For a detailed description of each parameter, refers to par. 7.5.



Some examples of Parameters Editing/Visualization, are reported below:

- Example 1 (P20) from 000 to 066:

P20 → **P20** →  → **000** → **000** →  ... until ... → **066** → **066** →  sets the desired value

→
→ **P21** → **P21**

- Example 2 (P26) from 360 to 300:

P26 → **P26** →  → **360** → **360** →  ... until ... → **300** → **300** →  sets the desired value →

→ **P26** → **P26**

7.4.3 Multiple pumps priority visualization

Accessing (see par. 7.2) to Multiple Pump Priority Visualization the Numeric display [6] shows the following information:

Pr1 (Pr1) .. **Pr3** (Pr3) or **Pr0** (Pr0).

Pr1 .. Pr3, indicate that the pump is communicating with others pumps and its priority order, is equal to the visualized number.

If Pr0 is visualized, it means that the pump doesn't detect communication with other pumps and it considers to be alone in the multi pumps bus.

The Multiple Pumps Priority Visualization is accessible also through P63.

7.4.4 Alarms and errors visualization

Alarms

If an alarm occurs, the Numeric display [6] shows the alarm code alternatively to the current Main Visualization as follows (Examples of visualizations):

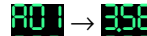
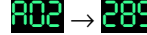
 → 356 (Ex. BAR)
 → 289 (Ex. 10xRPM)

...

The A01..A0x error code, indicate the type of alarm detected by the circulator.
 For more details about the Alarm codes detection and management, see par.7.6.

Errors

If a failure occurs, the Numeric display [6] shows a permanently Error code as follows:





...

The E01..E0x error code, indicate the type of error detected by the circulator.
 For more details about the Error codes detection and management, see par.7.6.

7.5 Software parameters

Introduction

The parameters are applicable for all Drives with the following exceptions:

- If a setting is transferred automatically on all drives within one system, this is marked with the symbol (Global) 
- If a parameter is read-only, this is marked with the symbol (Read-only) 

7.5.1 Status Parameters

P01. Required Value

This parameter shows the SOURCE and the VALUE of current required value.
 Visualization cycles between SOURCE and VALUE every 3 seconds.

SOURCES:

SP : internal required value Setpoint related to the control mode selected.

VL : external required value speed Setpoint related to 0-10V input.

VALUE, can represent a Speed or a Head, dependent from selected control mode.

In case of Head, the unit of measure is defined by parameter P41.

P02. Effective Required Value

This parameter is effective only if the control mode is MSE or MSY.

P02 shows the current required value that is calculated based on parameters P58 and P59.

(See paragraph 10.3, for detailed information about P02 calculation).

P03. Regulation Restart Value [0÷100]

This parameter defines (default value 100), in percentage (0-100%) of the required value (P01), the start value after pump stops.

If the REQUIRED VALUE is met and there is no more consumption, then the pump stops. The pump starts again when the pressure drops below P03.

This parameter is effective when:

Different from 100% (100%=off), and

Control Mode is HCS, MSE or MSY

P04. Auto-start [OFF-ON]

If P04 = ON (default value ON), then the drive starts automatically (in case of demand) following a power disconnection.

P05. Operating time months 

This parameter shows the amount of months of total operating time (drive supplied with power), to be added to P06.

P06. Operating time hours 

This parameter shows the amount of hours of total operating time, to be added to P05.

P07. Motor Time Months 

This parameter shows the amount of months of motor operating time, to be added to P08.

P08. Motor time hours 





This parameter shows the amount of hours of motor operating time, to be added to P07.

P09. 1ST ERROR 

This parameter holds the last error happened. The information displayed switches through the values:

- (Exx): xx reports the error code
- (Hyy): yy is the value of hours referred to P05-P06 when the error Exx happened
- (Dww):ww is the value of days referred to P05-P06 when the error Exx happened
- (Uzz): zz is the value of weeks referred to P05-P06 when the error Exx happened

Example of visualization:

 →  →  → 

P10. 2ND ERROR 

This parameter holds the second error happened. The information displayed switches through the values:

- (Exx): xx reports the error code
- (Hyy): yy is the value of hours referred to P05-P06 when the error Exx happened
- (Dww):ww is the value of days referred to P05-P06 when the error Exx happened
- (Uzz): zz is the value of weeks referred to P05-P06 when the error Exx happened

See P09 for a visualization example.

P11. 3RD ERROR 

This parameter holds the third error happened. The information displayed switches through the values:

- (Exx): xx reports the error code
- (Hyy): yy is the value of hours referred to P05-P06 when the error Exx happened
- (Dww):ww is the value of days referred to P05-P06 when the error Exx happened
- (Uzz): zz is the value of weeks referred to P05-P06 when the error Exx happened

See P09 for a visualization example.

P12. 4TH ERROR 

This parameter holds the fourth error happened. The information displayed switches through the values:

- (Exx): xx reports the error code
- (Hyy): yy is the value of hours referred to P05-P06 when the error Exx happened
- (Dww):ww is the value of days referred to P05-P06 when the error Exx happened
- (Uzz): zz is the value of weeks referred to P05-P06 when the error Exx happened

See P09 for a visualization example.

P13. Power Module Temperature 

This parameter shows the power module temperature, expressed in °C

P14. Inverter Current 

This parameter shows the actual current sourced by the frequency converter, expressed in [Amperes].

P15. Inverter Voltage 

This parameter shows the actual estimated input voltage of the frequency converter, expressed in [Volts].

P16. Motor Speed 

This parameter shows the actual motor rotational speed, expressed in [RPM x 10].

P17. Software version 

This parameter shows the Control Board software version.

7.5.2 Settings Parameters

P20. Password [0÷999]

The user can enter here the system password, which gives access to all system parameters: this value is compared with the one stored in P22.

When a correct password is entered, the system remains unlocked for 10 minutes, so that all the parameters are made accessible.

In case the password entered is not matching the value stored in P22, only the parameters up to P20 remain accessible.

P21. Jog mode [MIN÷MAX*]

When the user accesses to this parameter, it deactivates the internal controller of the drive and forces the actual Control Mode to ACt for all the time this parameter is in use: motor starts and the value of P21 becomes the set-point of ACt.

It can be changed just selecting a new value on P21 (in the interval between P27 and P26), not confirming it (otherwise the user exits from this temporary control).

P22. Set password [1÷999]

Set the system password (default value 66), to which the password entered in P20 PASSWORD has to correspond.

P23. Lock Function [OFF, ON]

By using this parameter (default value ON), the user can lock or unlock parameter settings in the main menu; default setting is OFF, so that all parameters are accessible.

In case the user sets P23 = ON, no parameter can be changed without inputting the system password in P20.

7.5.3 Drive Configuration Parameters

P25. Control mode [ACt, HCS, MSE, MSY]

This parameter sets the Control Mode (default value HCS).

- (ACt) Actuator mode
It is the control mode with which a single pump maintains a fixed speed at any flow demand. ACT will always try to minimize the error between the speed set-point and the actual rotational speed of the motor.
- (HCS) Hydrovar[®] Controller mode for Single pump.
It is the default control mode, provided for open hydraulic circuits, with which a single pump maintains a constant pressure at any flow demand: Hydrovar[®] algorithm, based on the set of parameters from P26 to P37 (see par. 7.5.3), is adopted.
For the characteristics of HCS, it is necessary the adoption (on the hydraulic plant) of an absolute pressure sensor, which gives to the drive the feedback pressure signal (by mean of External Pressure Sensor input [9,10] par. 5.5, configured by P40): HCS will always try to minimize the error between the pressure set-point and the feedback pressure signal.
(MSE) Hydrovar[®] Controller mode for Multiple pumps in Serial Cascade.
It is the control mode, provided for open hydraulic circuits, with which a set of pumps, connected by mean of the Multi-pump Protocol, maintains a constant pressure at any flow

* It depends on the hydraulic

demand: typical is the use of the Hydrovar® algorithm, based on the set of parameters from P26 to P37 (see par. 7.5.3).

For the characteristics of MSE:

- It is necessary the adoption (on the hydraulic plant) of an absolute pressure sensor for each pump, which gives to the set of drives the feedback pressure signal (by mean of External Pressure Sensor input [9,10] par. 5.5, configured by P40): MSE will always try to minimize the error between the pressure set-point and the feedback pressure signal.
- Maximum 3 pumps, all of the same type and power, can be connected by mean of the Multi-pump Protocol.
- The pumps are managed serially, meaning that only the last activated pump modulates its speed for maintaining the set pressure, while all the other running pumps in the system run at maximum speed.
- (MSY) Hydrovar® Controller mode for Multiple pumps in Synchronous Cascade
It is the control mode, provided for open hydraulic circuits, with which a set of pumps, connected by mean of the Multi-pump Protocol, maintains a constant pressure at any flow demand: typical is the use of the Hydrovar® algorithm, based on the set of parameters from P26 to P37 (see par. 7.5.3).

For the characteristics of MSY:

- It is necessary the adoption (on the hydraulic plant) of an absolute pressure sensor for each pump, which gives to the set of drives the feedback pressure signal (by mean of External Pressure Sensor input [9,10] par. 5.5, configured by P40): MSY will always try to minimize the error between the pressure set-point and the feedback pressure signal.
- Maximum 3 pumps, all of the same type and power, can be connected by mean of the Multi-pump Protocol.
- All the pumps are synchronized, meaning that all pumps in the system maintain the set pressure by running at the same frequency.

P26. Max RPM set [ACt set+Max*]

This parameter (default value depends on the hydraulic) sets the maximum speed of the pump, expressed in [RPM x 10]. Maximum speed is model dependant.

P27. Min RPM set [Min+ACt set*]

This parameter (default value depends on the hydraulic) sets the minimum speed of the pump, expressed in [RPM x 10]. Minimum speed is model dependant.

P28. Ramp 1 [1÷250]

This parameter (default value 3) adjusts the fast acceleration time expressed in [seconds], and it affects the control of the pump for HCS, MSE and MSY control modes.

P29. Ramp 2 [1÷250]

This parameter (default value 3) adjusts the fast deceleration time expressed in [seconds], and it affects the control of the pump for HCS, MSE and MSY control modes.

P30. Ramp 3 [1÷999]

This parameter (default value 35) adjusts the slow acceleration time expressed in [seconds], thus determining:

- the regulation speed of the internal Hydrovar® controller for small changes in demand.
- the constant outgoing pressure.

The ramp depends on the system which has to be controlled, and affects the control of the pump for HCS, MSE and MSY control modes.

* It depends on the hydraulic

P31. Ramp 4 [1÷999] 

This parameter (default value 35) adjusts the slow deceleration time expressed in [seconds], thus determining:

- the regulation speed of the internal Hydrovar® controller for small changes in demand.
- the constant outgoing pressure.

The ramp depends on the system which has to be controlled, and affects the control of the pump for HCS, MSE and MSY control modes.

P32. Ramp Speed Min Acceleration [2.0÷25.0] 

This parameter (default value 2.0) sets the fast running up time expressed in [seconds], and represents the acceleration ramp used by the internal Hydrovar® controller until the minimum speed of the pump, defined in P27, is reached.

This parameter affects the control of the pump for HCS, MSE and MSY control modes.



P33. Ramp Speed Min Deceleration [2.0÷25.0] 

This parameter (default value 2.0) sets the fast running down time expressed in [seconds], and represents the deceleration ramp used by the internal Hydrovar® controller for stopping the pump once the minimum speed of the pump, defined in P27, is reached.

This parameter affects the control of the pump for HCS, MSE and MSY control modes.

P34. Speed Min Configuration [STP, SMI] 

This parameter (default value STP) defines the operation of the internal Hydrovar® controller once the minimum speed of the pump, defined in P27, is reached.

- If P34 = STP () , once the required pressure is reached and no further consumption is needed, the pump speed decreases to the selected P27 value: Hydrovar® controller then keeps running for the selected P35 time interval and after this time stops automatically.
- If P34 = SMI () , once the required pressure is reached and no further consumption is needed, the pump speed decreases to the selected P27 value: Hydrovar® controller then keeps running at that speed (the pump never stops automatically).

This parameter affects the control of the pump for HCS, MSE and MSY control modes.

P35. Smin time [0÷100] 

This parameter (default value 0s) sets the delay time expressed in [seconds], before a shut-off below P27 occurs, and is used by the internal Hydrovar® controller only if P34 = STP.

This parameter affects the control of the pump for HCS, MSE and MSY control modes.

P36. Window [0÷100] 

This parameter (default value 10), expressed as percentage [%] of the pressure set-point, sets the range for ramp control, thus defining the region, around the pressure set-point, where the internal Hydrovar® controller uses slow acceleration and deceleration ramps instead of fast ones

This parameter affects the control of the pump for HCS, MSE and MSY control modes.

P37. Hysteresis [0÷100] 

This parameter (default value 80), expressed as percentage [%] of P36, sets the regulation hysteresis for slow ramp switching among acceleration and deceleration ones

This parameter affects the control of the pump for HCS, MSE and MSY control modes.

P38. Speed Lift [0÷MAX^{*}] 



This parameter (default value P27) sets the speed limit for the required lift value where the required pressure starts to be increased.

P39. Lift Amount [0÷200] 

This parameter (default value 0) sets the lift amount for the required lift value in HVAC systems or for compensation of friction losses in long pipe work. It determines the increase of the set value until the maximum is reached.

7.5.4 Sensor Configuration Parameters

P41. Pressure Sensor Unit Of Measure [BAR, PSI] 

This parameter (, ) (default value BAR) sets the unit of measurement for the pressure sensor and affect also the Parameter LED for Head visualization (see par. 7.3.4.2).

P42. Pressur Sensor Full Scale-4÷20mA [0.0÷25.0BAR] / [0.0÷363PSI] 

This parameter (default value depends on the hydraulic) sets the Full Scale value (in BAR or PSI, depending on P41) for the 4÷20mA pressure sensor connected to the analog input [9,10], described in par. 5.5.

P44. Zero Pressure Auto-Calibration

This parameter lets the user perform the initial auto-calibration of the pressure sensor, so that the drive compensates for the offset signal of the sensor at zero pressure (due to the tolerance of the pressure sensor itself).

The steps for performing the auto-calibration are:

1. access to P44 when the hydraulic plant is at 0 pressure (no water inside) or with the pressure sensor disconnected from the pipes: the actual value for 0 pressure is displayed
2. start the auto-calibration by pressing  or push button (see par. 7.2)
3. at the end of the auto-calibration, the 0 pressure is displayed (or the message “---“ (---) if the sensor signal is out of the admitted tolerance).



P45. Pressure Minimum Threshold [0÷42] 

This parameter (default value 0) sets a minimum pressure threshold: if the system pressure gets below this value for the time defined in P46, then the drive returns the low pressure error code E14.

P46. Pressure Minimum Threshold - Delay Time [1÷100] 

This parameter (default value 2) sets the delay time expressed in [seconds], witch the drive shall wait for, remaining the system pressure continuously below P45, before generating the low pressure error code E14.

P47. Pressure Minimum Threshold – Automatic Error Reset [DIS, ENB] 

This parameter (, ) (default value ENB) enables/disables automatic retries performed by the drive when low pressure error is detected.

P48. Lack Of Water Switch Input , , 

This parameter (default value ERR) enables/disables for the drive the management of the Lack Of Water Input (see par. 5.5 [13, 14]), and moreover defines the behaviour of the drive when the Lack Of Water Input is enabled and the switch is open:

- If P48 = DIS, the drive doesn't manage at all the information coming from the Lack Of Water Input (which is in practice disabled)
- If P48 = ALr, the drive reads the Lack Of Water Input (which is enabled) and reacts, to the Lack Of Water Switch opening, by displaying the relative alarm A06 on the display, but it keeps on running the motor

If P48 = Err, the drive reads the Lack Of Water Input (which is enabled) and reacts, to the Lack Of Water Switch opening, by stopping the motor and generating the relative error code E11; the

* It depends on the hydraulic

error condition is further removed (and the motor started accordingly) when the Lack Of Water Switch closes again.

7.5.5 RS485 Interface Parameters

P50. BMS Comm Protocol [MOD, bAC]

This parameter (default value MOD) selects a specific protocol on the communication port: possible settings are MOD (Modbus RTU) or bAC (BACnet MS/TP)

P51. BMS Comm Protocol – ADDRESS [1÷247] / [0÷127]

This parameter sets the desired address for the drive, when connected to any external device, depending on the protocol selected in P50:

- If P50 = MOD, the address can be any value in the range 1÷247
- If P50 = bAC, the address can be any value in the range 0÷127

P52. BMS Comm Protocol – BAUDRATE [4.8, 9.6, 14.4, 19.2, 38.4, 56.0, 57.6 Kbps]

This parameter (4.8, 9.6, 14.4, 19.2, 38.4, 56.0, 57.6) (default value 9.6) sets the desired baudrate for the communication port.

P53. BACNET Device ID Offset [0÷999]

This parameter (default value 002) sets hundreds, tens and units of the BACnet Device ID. (BACnet Device ID default value = 84002)

P54. BMS Comm Protocol – CONFIGURATION [8N1, 8N2, 8E1, 8o1]

This parameter (default value 8N1) sets the length of the data bits, the parity and the length of the stop bits.

7.5.6 Multipump Configuration Parameters

All these parameters affect MSE and MSY control modes.

P55. Multipump – Address [1÷3]

This parameter (default value 1) sets an address (1÷3) for each pump: the user shall manage it following the subsequent rules:

- Each pump needs an individual pump-address (1÷3)
- Each address can only be used once.

P56. Multipump – Max Units [1÷3]

This parameter (default value 3) sets the maximum number of units that operate simultaneously.

P57. Multipump – Switch Interval [0÷250]

This parameter (default value 24) sets the switch interval expressed in [hours] for the cyclic change-over: it allows an automatic change-over of the MASTER pump and the assist pumps.

As soon as the switch time is reached the next pump becomes MASTER and the counter restarts, thus ensuring a balanced distribution of the operating hours amongst all pumps.

P58. Multipump – Actual Value Increase [0.0÷25.0BAR] / [0.0÷363PSI]

This parameter (in BAR or PSI, depending on P41, default value 0.35 bar), affects the calculation of P02 to improve the Multipump control as described in the paragraph 10.3.

P59. Multipump – Actual Value Decrease [0.0÷25.0BAR] / [0.0÷363PSI]

This parameter (in BAR or PSI, depending on P41, default value 0.15 bar), affects the calculation of P02 to improve the Multipump control as described in the paragraph 10.3.

P60. Multipump – Enable Speed [P27÷P26]

This parameter (default value depends on the hydraulic) sets the speed that a pump shall reach before starting the next assist pump, after a system pressure drops below the difference: P02 – P59.

P61. Multipump Synchronous – Speed Limit [P27÷3600]

This parameter (default value depends on the hydraulic) sets the speed limit: the first assist pump shuts off if the speed goes below this parameter's value.
This parameter only applies to cascade synchronous!

P62. Multipump Synchronous – Window [0÷100]

By setting the speed window (default value 150), expressed as [RPMx10], this parameter represents the limit for switching off the next assist pump.
This parameter only applies to cascade synchronous!

P63. Multipump – Priority

This parameter shows the pump priority value in the Multipump set.
(See par. 7.4.3 for further information)

P64. Multipump – Revision

This parameter shows the Multipump protocol revision value used.

7.5.7 Test Run Configuration Parameters

Test Run is a particular function which starts the pump after the last stop, in order to prevent the pump from blocking.

P65. Test Run – Time Start [0÷100]

This parameter (default value 100), expressed in [hours], sets the time after which, once the pump stopped for the last time, the Test Run will start.

P66. Test Run – Speed [Min÷Max]

This parameter (default value 200) sets the pump rotational speed for the Test Run expressed in [RPMx10]. Min and Max speed are model dependant.

P67. Test Run – Time Duration [0÷180]



This parameter (default value 10) sets the time duration for the Test Run expressed in [seconds].

7.5.8 Special Parameters

P68. Default Values Reload [,

This parameter, if sets to RES, after confirmation, performs a factory restore operation that loads the default parameters values.

P69. Avoid Frequently Parameters Saving [NO, YES] [6]

By setting this parameter (, ) (default value NO) to YES, the user can limit the frequency with which the drive stores the required value P02 in its EEPROM memory; this could be particularly useful, not to impact EEPROM retention life, especially in applications with a BMS controller, which could force a continuous variation of the required value for fine regulation purposes.

7.6 Fault finding

Referring to par. 7.4.4:

- In case of any alarm that allows the motor to keep on running, the display shows alternatively alarm code and the value of the current motor rotational speed or of the current (estimated or measured) pressure, while the STATUS indicator becomes orange
- In case of a failure that stops the motor, the display shows the error code permanently and the STATUS indicator becomes red.

7.6.1 Alarm codes

Table 15: Alarm codes

Alarm code	Description	Cause
A03	Derating	Temperature too high
A05	Data memory alarm	Data memory corrupted
A06	LOW alarm	Lack of water detection (if = ALR)
A15	EEPROM write failure	
A20	Internal alarm	
A30	Multi-pump connection alarm	Multi-pump connection corrupted
A31	Multi-pump comm. lost	Multi-pump connection lost

7.6.2 Error codes

Table 16: Error codes

Error code	Description	Cause
E01	Internal communication error	Internal communication lost
E02	Motor overload error	High motor current
E03	DC-bus overvoltage error	DC-bus overvoltage
E04	Trip control error	Motor stall
E05	EEPROM Data memory error	EEPROM Data memory corrupted
E06	Grid voltage error	Voltage supply out of operating range
E07	Motor winding temperature error	Motor thermal protection trip
E08	Power module temperature error	Frequency converter thermal protection trip
E09	Generic Hardware error	Hardware error
E10	Dry-run error	Dry run detection
E11	LOW error	Lack of water detection (if = ERR)
E12	Pressure sensor error	Missing pressure sensor (not present in ACT)
E14	Low pressure error	Pressure below minimum threshold (not present in ACT)
E30	Multi-pump protocol error	Incompatible multi-pump protocol

8 Maintenance

8.1 General



Electrical Hazard:

Before any service or maintenance disconnect the system from the power supply and wait at least 4 minutes before starting work on or in the unit (the capacitors in the intermediate circuit are discharged by the internal discharge resistors).

The unit does not require any special maintenance.

Check list

- Make sure that the cooling fan and the vents are free from dust.
 - Make sure that the ambient temperature is correct according to the limits of the unit.
 - Make sure that qualified personal perform all modifications of the unit.
 - Make sure that the unit is disconnected from the power supply before any work is carried out. Always consider the pump and motor instruction.
- For further information, contact the local distributor.

8.2 Check the functions and parameters

If the hydraulic system is changed then follow this procedure:

1. Make sure that all functions and parameters are correct
2. Adjust the functions and parameters if necessary.

9 Technical Reference

9.1 Example: ACT control mode with analog 0-10V input

Graph

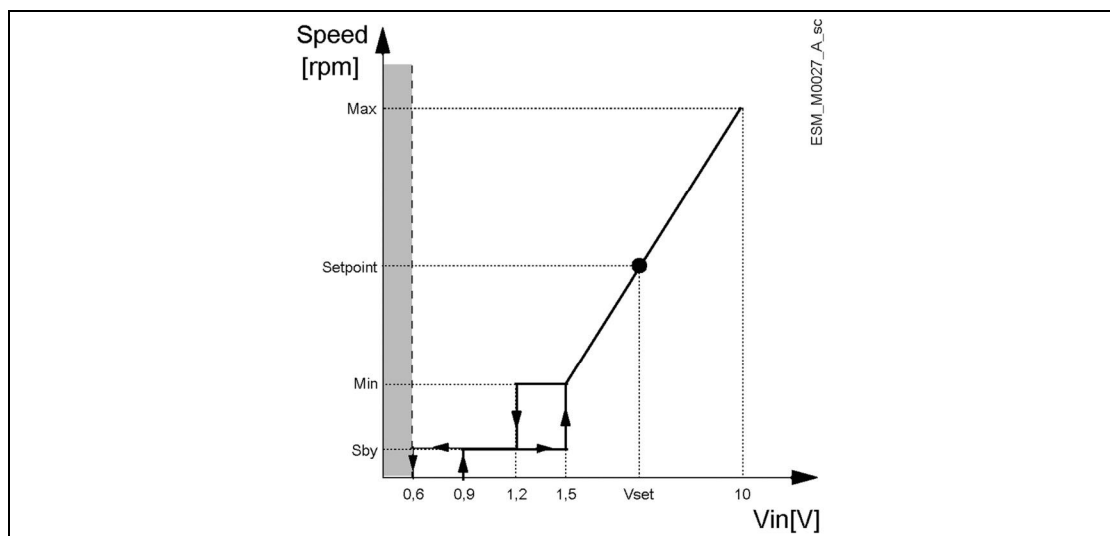

Figure 18: ACT control mode diagram

Table 17: Description

Gray area	→ Missing input Voltage detection threshold
Speed [RPM]	→ Actual Speed related to analog 0-10V input Voltage value (see par. 5.4, table 13 contacts 7 and 8)
Max	→ P26 (Max RPM set)
Min	→ P27 (Min RPM set)
Setpoint	→ Example of Actual Speed related to a specific Vset Voltage value
Sby	→ Input Voltage at which the motor goes in Stand by
Vin [V]	→ Input Voltage value to control the pump in ACT mode Different thresholds are managed by the pump, from Non-detection to Max speed.)

For further information about ACT control mode and parameters adjustment, see par. 7.5.3.

9.2 Example: Ramp Settings

Graph

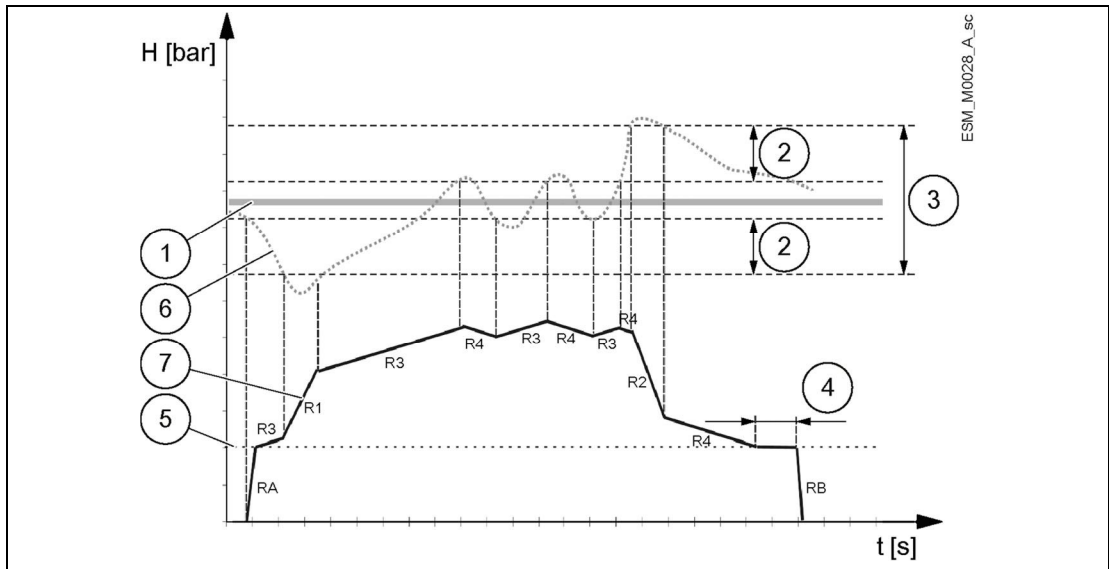

Figure 19: Ramp settings

Table 18: Description

1	P01 (Required Value)
2	P37 (Hysteresys) in % of P36 (Window)
3	P36 (Window) in % of P01 (Required Value)
4	P35 (Smin Time)
5	P27 (Min RPM set)
6	→ Actual Head
7	→ Actual Speed
RA	→ P32 (Ramp Speed Min Acceleration)
RB	→ P33 (Ramp Speed Min Deceleration)
R1	→ P28 (Ramp 1) - speed ramp fast increase

R2	→ P29 (Ramp 2) - speed ramp fast decrease
R3	→ P30 (Ramp 3) - speed ramp slow increase
R4	→ P31 (Ramp 4) - speed ramp slow decrease

For further information about Ramps adjustment, see. par. 7.5.3.

9.3 Example: Effective Required Value

Pumps activation in cascade modes:

1. Lead pump reaches its P60 (Enable Speed).
2. Actual value falls to the cut in-value of the 1st assist pump.
The 1st assist pump switches on automatically. (Cut in-value = P01 (Required Value) - P59 (Actual Value Decrease))
3. A new required value, P02 (Effective Required Value) is calculated after the start up.

Calculation of Effective Required Value in Cascade Serial (MSE):

K = number of active pumps ($k > 1$)

Pr = pump priority

- If $K - Pr > 0$
P02 (Effective Required Value) = P01 (Required Value) + $(K - Pr) * P58$ (Actual Value Increase)
- If $K - Pr = 0$
P02 (Effective Required Value) = P01 (Required Value) + P58 (Actual Value Increase) - P59 (Actual Value Decrease)

Calculation of Effective Required Value in Cascade Synchronous (MSY):

K = number of active pumps ($k > 1$)

- If $K > 1$
P02 (Effective Required Value) = P01 (Required Value) + $(K - 1) * P58$ (Actual Value Increase)
- If $K = 1$
P02 (Effective Required Value) = P01 (Required Value) + P58 (Actual Value Increase) - P59 (Actual Value Decrease)

Behavior of P58 (Actual Value Increase) and P59 (Actual Value Decrease):

- if P58 (Actual Value Increase) = P59 (Actual Value Decrease) → Pressure constant, independent of how many pumps are in operation.
- if P58 (Actual Value Increase) > P59 (Actual Value Decrease) → Pressure rises when assist pump switches on.
- if P58 (Actual Value Increase) < P59 (Actual Value Decrease) → Pressure falls when assist pump switches on.

Xylem Service Italia S.r.l.
Via Vittorio Lombardi 14
36075 – Montecchio Maggiore (VI) - Italy
www.xyleminc.com/brands/lowara

